



Atlas Copco



Atlas Copco

GHS 2002 VSD⁺

VACUUM PUMP



GHS 1402-2002 VSD⁺

Next-generation vacuum pumps
with HEX@™ connectivity and control

GHS VSD⁺ with HEX@™: A game changer

Building on our revolutionary GHS VSD⁺ range of variable speed-driven oil-injected screw vacuum pumps, we've taken a leap ahead and raised the game. The GHS 1402-2002 VSD⁺ has a **new design for better performance, optimal oil separation, a smaller footprint and an innovative new controller** which puts you in gear for **Industry 4.0**.

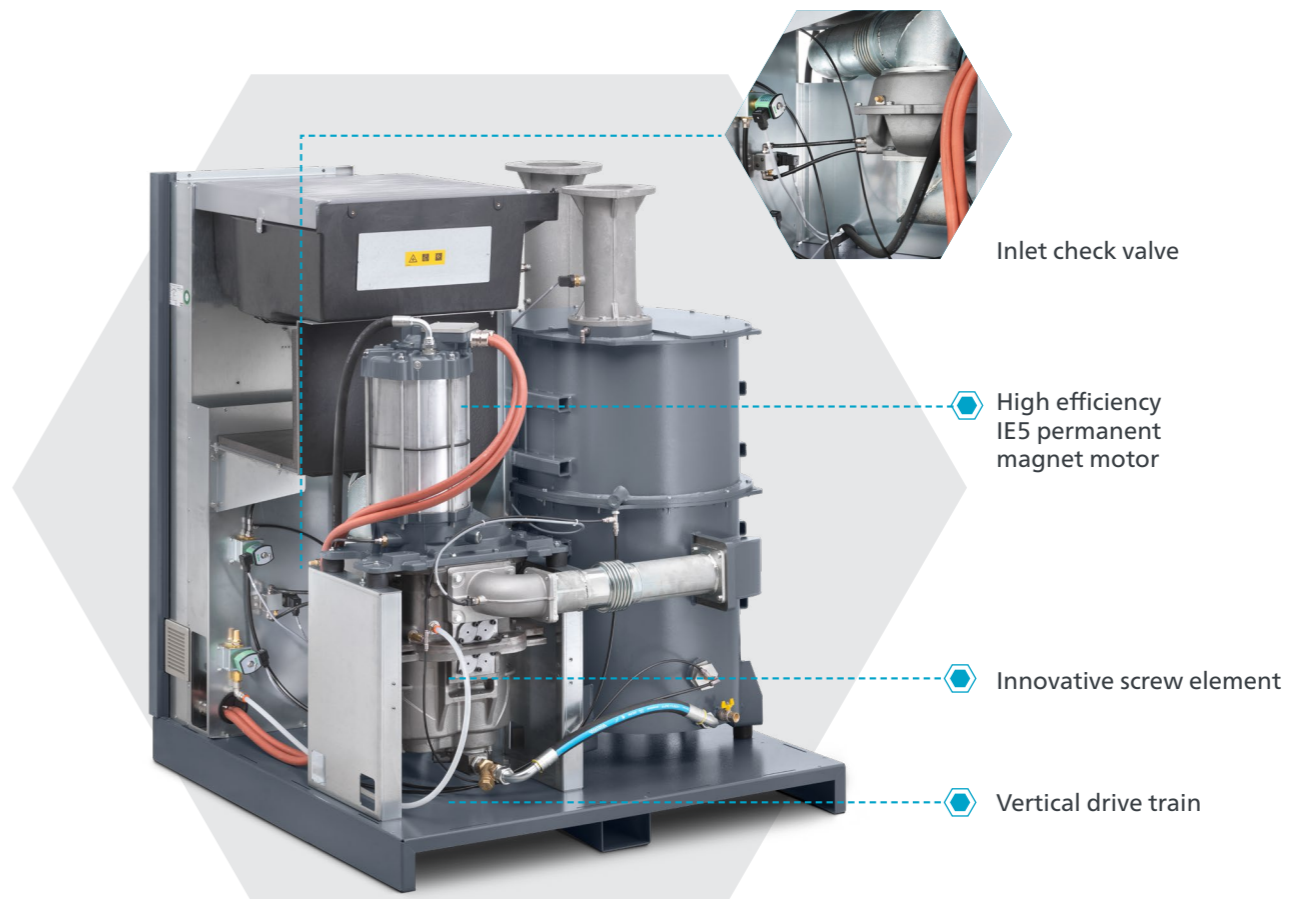
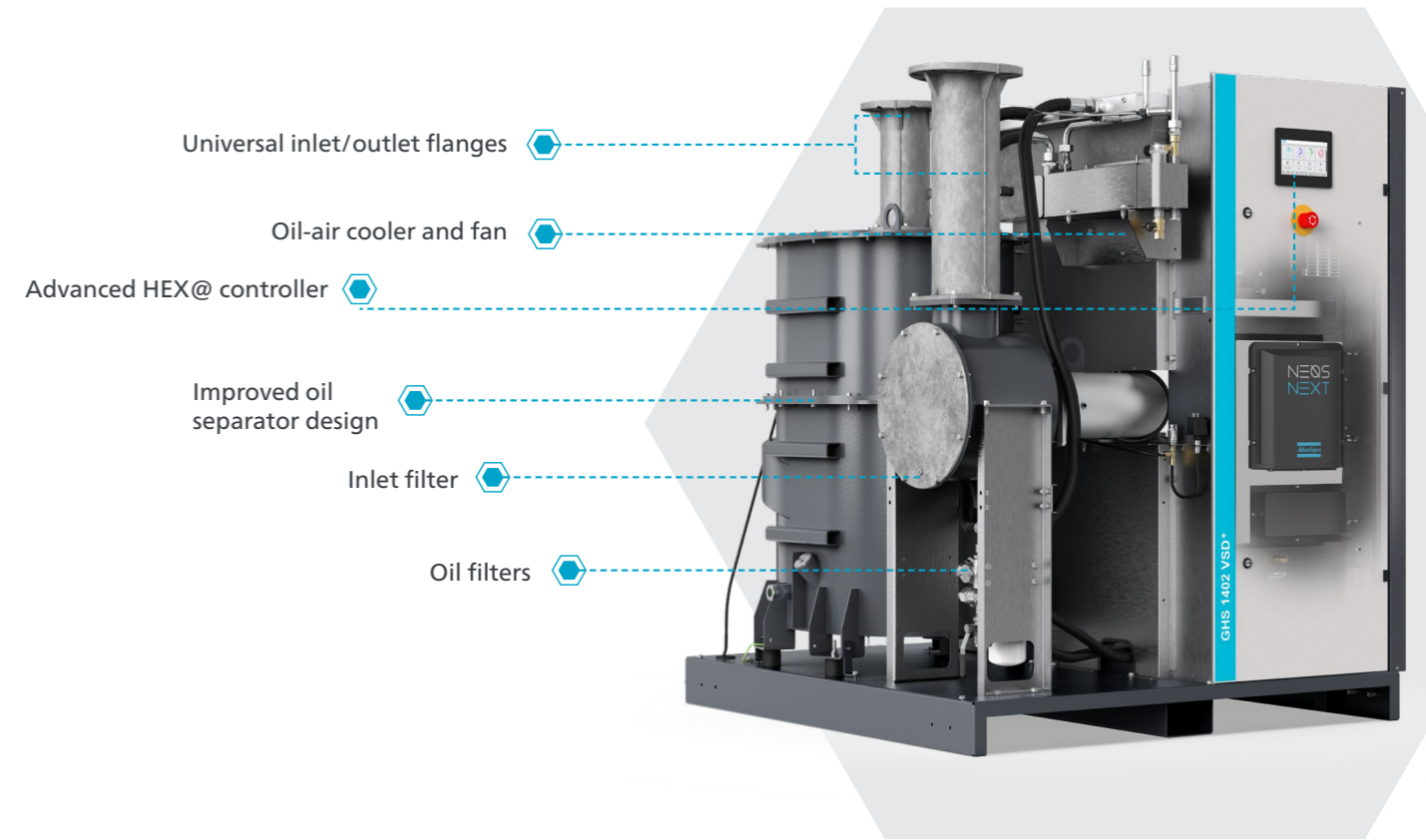

Highlights

High efficiency permanent magnet motor IE5

GHS 1402-2002 VSD⁺ is equipped with a permanent magnet assisted synchronous reluctance motor. The characteristic of this motor technology is to have particularly high efficiencies at all speeds, which makes it perfectly suited for variable speed. The efficiency of this motor is equivalent to IE5. The motor is cooled by the oil of the pump, ensuring an optimal cooling at all speeds. Another great advantage: the motor bearings are also lubricated by the oil, no need to regrease them at regular intervals. There is no extra fan on the motor which means less power consumption and less noise. This also results in a compact design. Besides, this motor is IP66 which makes it robust in dusty environments.



Innovative oil-injected screw element with compression optimization valves

At the core of the GHS 1402-2002 VSD⁺ series is Atlas Copco's high-performance pumping element. Innovations in engineering have led to a new element design that allows a high pumping speed curve optimized for rough vacuum applications and long intervals between overhauls. With the innovative compression optimization valves, the element has excellent flow at any rough vacuum level.

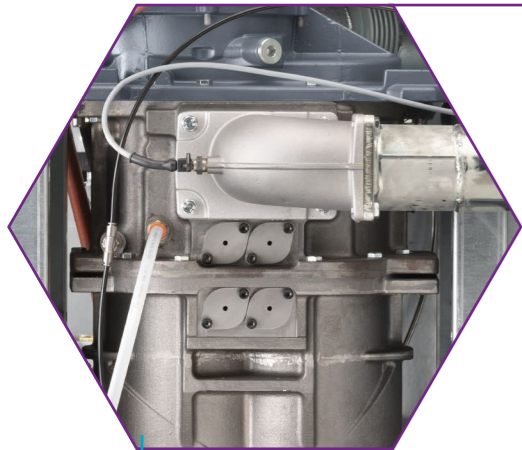

Cyclonic oil separation

The GHS 1402-2002 VSD⁺ benefits from excellent oil carryover thanks to its cyclonic design. The cyclones efficiently separate oil from the air by centrifugal force. The oil separator elements then carry out the last separation step. This leads to an oil discharge at the exhaust that is lower than 1.5mg/m³.

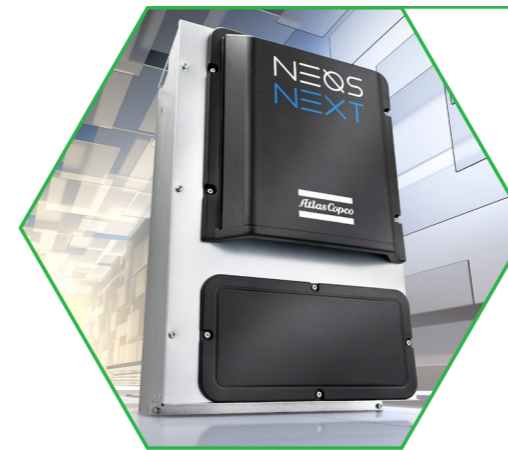

Variable Speed Drive

The GHS 1402-2002 VSD⁺ feature Atlas Copco's in-house designed Neos Next inverter. Building on the first-generation Neos inverter, the Neos Next second-generation inverter revolutionizes inverter performance to set new standards in VSD energy savings, sustainability and reliability. With the Neos Next inverter combined with set-point control, the pump delivers the pumping speed needed for the process. With these vacuum pumps you can potentially save 50%* or more in energy costs.

Oil-injected rotary screw vacuum pumps are also the ideal technology to combine with variable speed drives as they have the largest turndown ratio on the market; offering the largest range of pumping speed on the same model. In addition, the buildup in a separated cubicle ensures efficient heat dissipation.

*In most applications compared to traditional fixed speed vacuum technologies based on measurement with our Vbox energy audit tool.

The Neos Next is a prime example of Atlas Copco's continued investment in sustainable innovation. Because significant reductions in energy use mean lower emissions. And, because it has fewer components, the Neos Next has a smaller impact on the environment and further contributes to the sustainability of the Atlas Copco VSD range.



Flow diagram

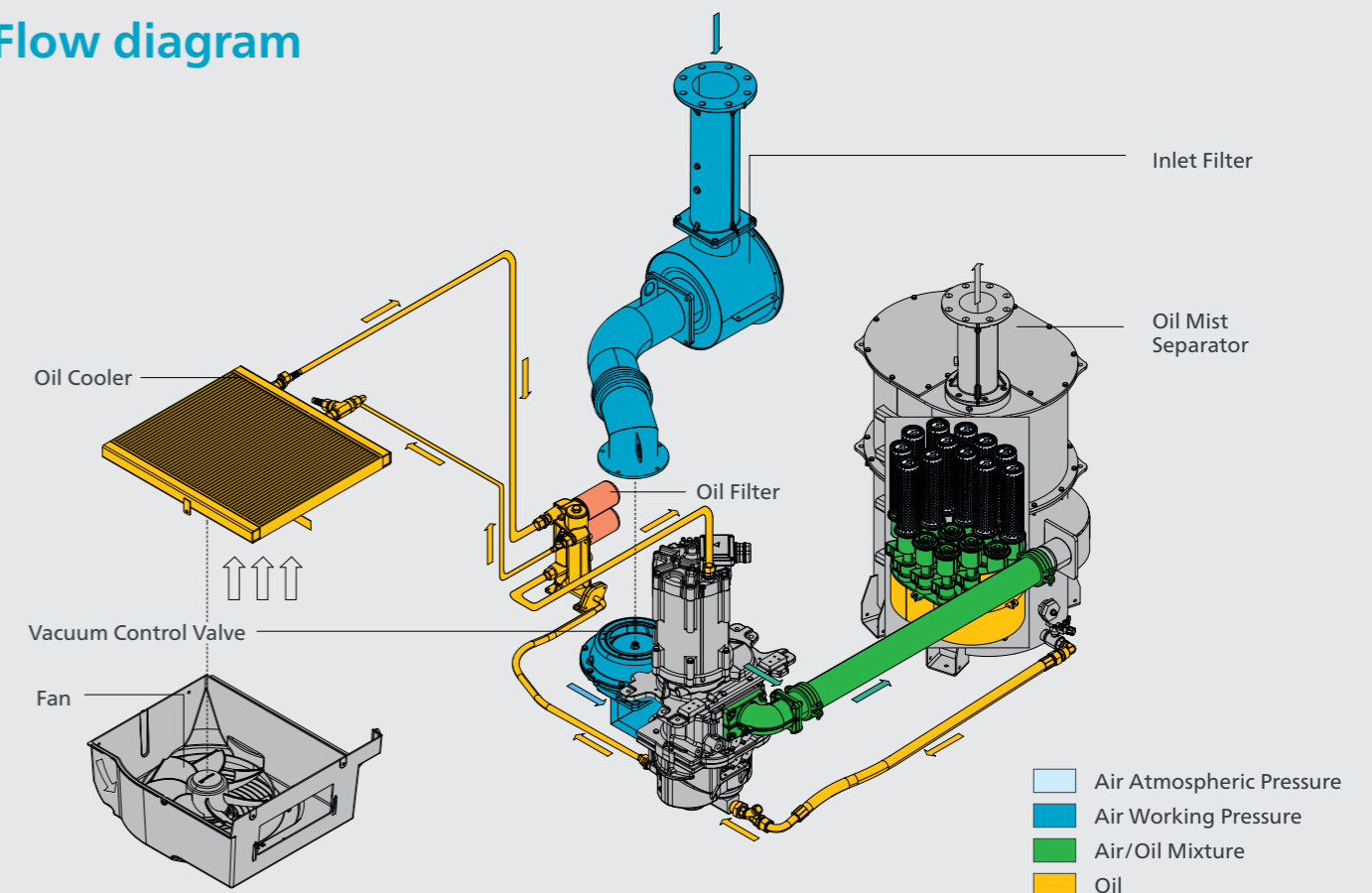

Features and Benefits

Performance & Efficiency

- New Atlas Copco oil-injected screw element
 - » Latest Atlas Copco screw profile
 - » Innovative **compression optimization valves** allowing high pumping speeds at rough vacuum
 - » Technology with the high turndown ratio
- Permanent magnet motor
 - » **IE5 efficiency**: high efficiencies at all speeds and demand levels
 - » Optimal cooling by oil
- Variable speed
 - » **Vacuum on demand** means the motor speed and the power consumption changes as per the process demand
 - » Stable vacuum level
 - » Very large turndown ratio



Energy savings*

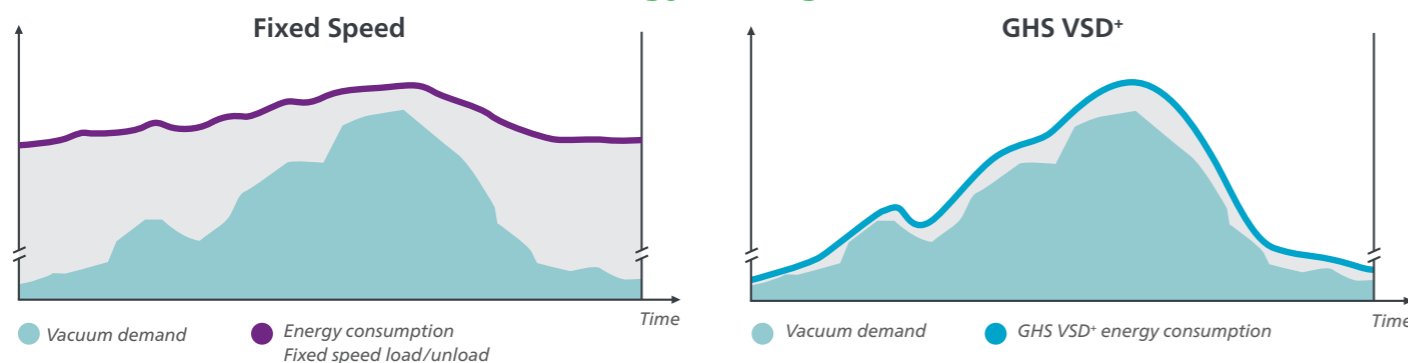

**In most applications compared to traditional fixed speed vacuum technologies based on measurement with our Vbox energy audit tool.*

Ready for industry 4.0

- Connected controller
 - » Access to the User Interface from any device equipped with a web browser (smartphone, laptop, PC, tablet)
- Trend visualization
 - » Plot the energy consumption over time
 - » Visualize different parameters to better understand behavior and optimize your pump
- Smart functionalities introduced
 - » Making the pump even more suitable for specific applications (cyclic, etc)
 - » Making the pump smarter (insight card, smart scheduling, leak detection, overboost, predictive maintenance, etc.)

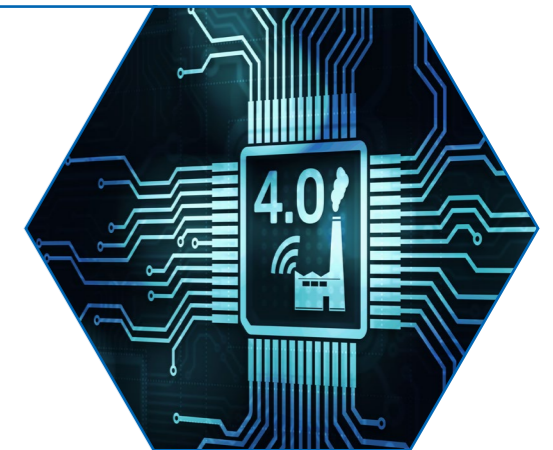

Working environment and easy installation

- Low life cycle with its long overhaul interval
- Excellent oil separation with cyclones
 - » Oil retention < 1,5 mg/l
- Noise reducing canopy
 - » Low noise level (58-78dB(A))
- Compact design thanks to vertical drive train
 - » Small footprint (1360 mm x 1460 mm)
- Universal flanges
- Inlet filter included as standard
- Control check valve included as standard



Key options

- Humid
 - » For high process water capacity
- Pumpdown optimization
 - » For faster pumpdown time
- Energy recovery
 - » Around 80% of energy can be recovered from the heat
- High ambient version (HAV)
 - » The pump can be used in higher ambient temperature, up to 50°C



HEX@™: Sixth sense intelligence through connectivity and control

With HEX@ you can **monitor and control** your pump from anywhere and at any time. You can receive feedback and review pump operating status, vacuum levels and upcoming scheduled events for your vacuum system.

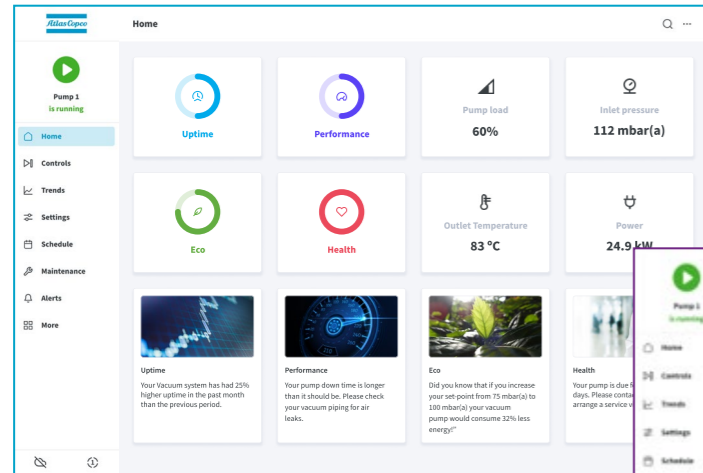

Screens showing KPIs for process optimization



Access and visualize pump trends, such as pressure and temperature



User-friendly interface options (above and right) by which to access Hex@'s functionalities

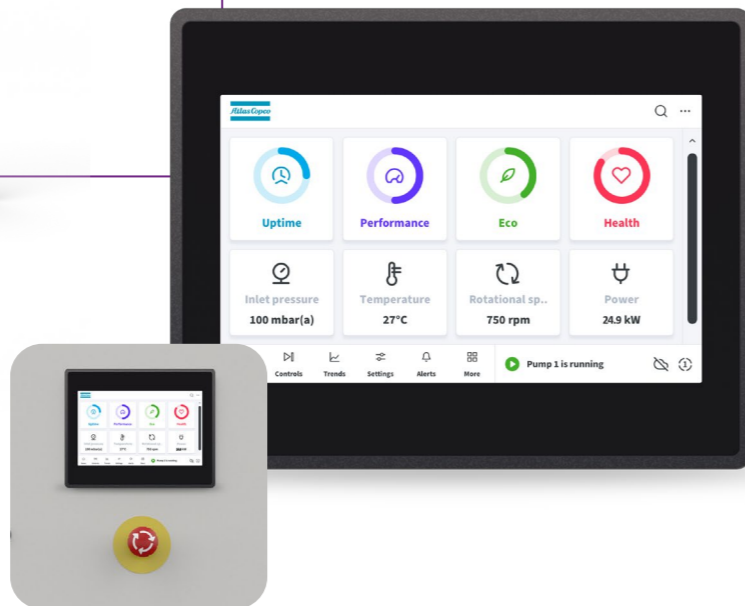

Automated insights and updates

HEX@ offers the benefits of having a connected device such as automatic software updates, access to future released functionality and increased understanding into vacuum performance. HEX@ will also provide insights, recommendations and feedback based on pump performance both current and historically. Perhaps the energy efficiency of the vacuum pump can be improved, or your maintenance interval can be extended? HEX@ will empower you to take proactive steps to optimize your vacuum system and maximize your production.

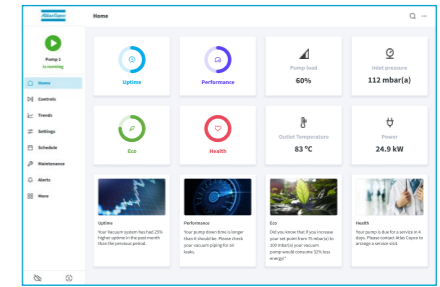

Configurable interface

With clear presentation and intuitive layout, the HEX@ ergonomic interface is quick and straightforward to navigate. Unlike traditional control interfaces, HEX@ allows you to configure parts of the home screen to display the information that is most important and relevant to you.

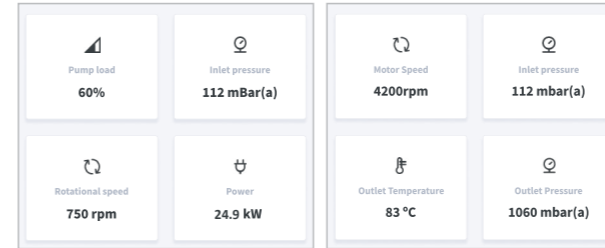

Secure web-based interface

This is possible by accessing your secure, web-based user interface to connect directly to your pump (or fleet of pumps). From your web-enabled device, PCs, laptops, tablets or smartphones, you can control and monitor your pump like you were standing right next to it.

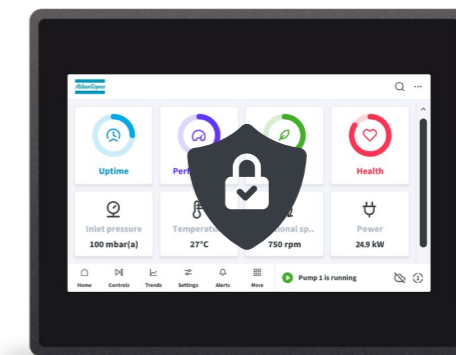

Smart functionalities

HEX@ also has smart functionalities which let you, for example, plan specific functions outside the production time – this can be set either on calendar day or running hours. You can also switch between operating modes which means you can save your operation settings for future convenience, moving between setting profiles according to the needs of production.

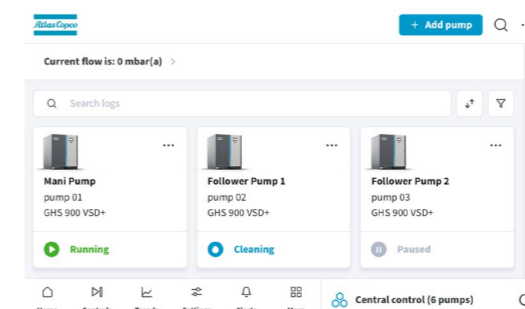

The power of trends

Multiple metrics

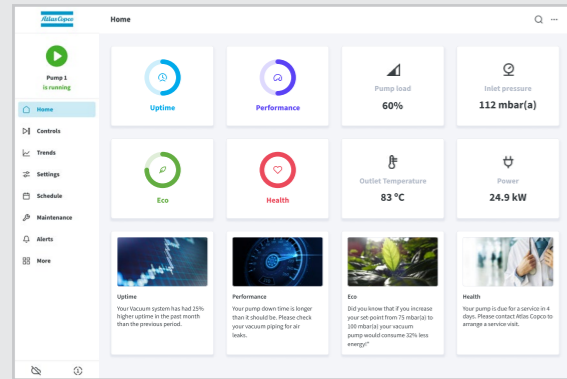

- View trends of multiple measured metrics over a period of time
- Compare different metrics to understand what is happening in relation to your process
- Can include: Inlet pressure, motor speed, power consumption, oil temperature and more.

HEX@: Optional HMI features

» 7" Touch HMI

- Market-leading interface

» Configurable home screen

- Display the parameters you choose and prioritize
- Flexible software means you can display different parameters over time. See what you want, when you want



Flexible Connectivity

- HEX@ allows you to integrate your vacuum pump into your system to the level YOU desire. Using the protocols you prefer. Whether using an ethernet cable, a WiFi module or another communication protocol to integrate your vacuum system, HEX@ can support you. You even have the option to connect using our GENIUS cellular network.
- To ensure no customer is left behind, HEX@ fully supports the latest and most common protocols found in industrial markets today. Rest assured, we can offer you an option to connect to your vacuum pump.

Modbus-RTU

Modbus TCP

EtherNet/IP

OPC UA

PROFI BUS

PROFI NET

EtherCAT

HEX@GRID: One controller, multiple pumps

Got multiple pumps? All you need is one HEX@GRID to build a truly integrated central system.

HEX@GRID Standard

Central box to control all your vacuum pumps

- Compatible with HEX@, MK5 and Fixed Speed machines
- Virtual machine control
 - » VSD Leader pump
 - » Follower pumps running to a settable speed between 60% and 100% of the max speed. The user can choose!
- 10% energy savings or more vs basic sequencers
- Connect up to 8 vacuum pumps

HEX@GRID Optimizer

Unlike traditional intelligent multi-pump controllers, using combinations of pumping speeds to achieve total pumping performance, Optimizer adds an extra dimension by taking into account the actual power consumed by each individual vacuum pump at every operating point.

Optimizer not only finds the best combination of pumping speeds to meet the demand, But considers all combinations pumping speeds and the total energy consumed.

- Compatible with HEX@, MK5 and Fixed Speed machines
- Optimizer Control Algorithm
- 20% energy savings or more vs basic sequencers
- Connect up to 20 vacuum pumps

HEX@GRID Central Control

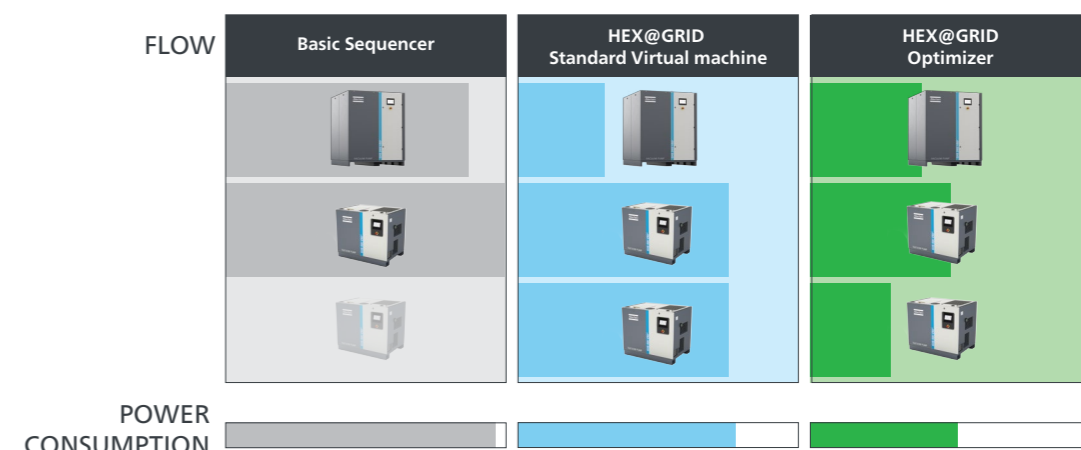

Applications

The GHS 1402-2002 VSD* is optimized for rough vacuum, making it ideal for a large range of applications.



Forming and shaping applications:

- Vacuum formed trays for packaging (food, cosmetics, electronics, medical)
- Thermoformed plastic components (automotive, parts, luggage, bath tubs, white goods)
- Injection molding EPS/EPP (automotive and aeronautical parts)

Preserving applications:

- Central vacuum systems for food packaging machines (meat, fish, poultry, cheese)
- Large chambers packaging machines, in line or rotary (large cuts meat, cheese blocks)
- Carousel packaging machines (coffee, snacks)

When a clean environment is essential:

- Altitude simulation
- Lamination (wood industry)
- House vacuum
- Electronic industry

Humid applications:

- Clay extrusion (Roof tile and bricks manufacture)
- Pipeline drying
- Vacuum cooling (vegetables, flowers and bakery products)

Holding, lifting, conveying and moving applications:

- Pick & Place (electronics)
- Envelope manufacturing
- General packaging
- Woodworking
- Paper converting
- Cigarette manufacturing
- Canning
- Conveying (CVS for plastic pellets conveying)
- Sewage (large civic stations)

Options to fit your needs



Humid

Suitable for high water content duties, for applications such as plastics, clay extrusion, drying pipelines, salad cooling, freeze drying, etc. The unit is fitted with tighter and higher temperature control, additional control logic and synthetic oil.



High Ambient Version (HAV)

It enables the machine to run up to 50°C ambient temperature.



Pump-down optimization

Ensure shortest possible pump-down time, anticipate next cycle, with optimized energy consumption.



ΔP control

- The vacuum system will work to maintain a constant difference of pressure between measured atmospheric pressure and pressure for production. This option is particularly useful for region with high fluctuations on ambient pressure.
- Maintain production and product quality.



Overboost

Exclusive for fast pumpdown application, it allows to increase the pumping speed during short cycle and decrease pump-down time.



Predictive maintenance

Allows to monitor the pump and predict maintenance intervals taking into account the real conditions of your pump.

Performance curves

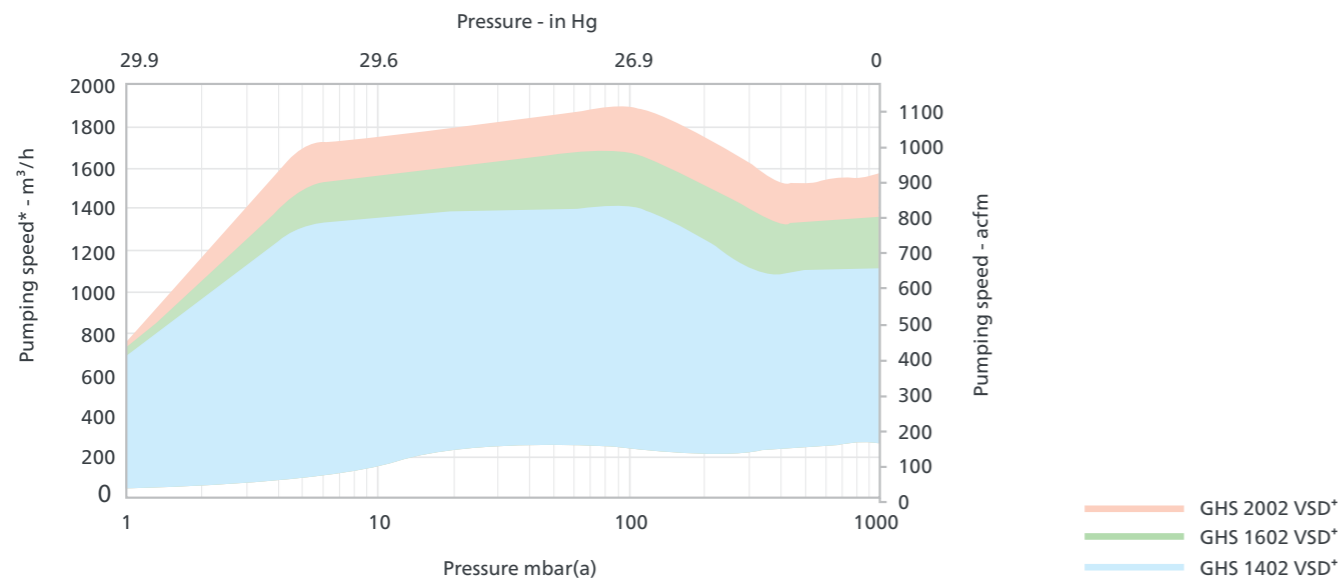

Technical Data

Model	Ultimate pressure		Frequency range	Average absorbed power at minimal speed		Nominal motor rating		Noise level (ISO 2151)	Oil capacity		
	mbar(a)	torr		kW	HP	kW	HP		L	Gal	
GHS 1402 VSD*	0.35	0.26	20 - 166	3.5	4.7	22	29.5	58 - 74	45	11.9	
GHS 1602 VSD*			20 - 200			30	40				58 - 77
GHS 2002 VSD*			20 - 233			37	50				

*Pumping speed at element inlet at steady state - according ISO 21360-1:2012 (E).
Note: The pump will achieve higher pumping speed than shown here when used in transient pump down operation.

Dimensions and weight

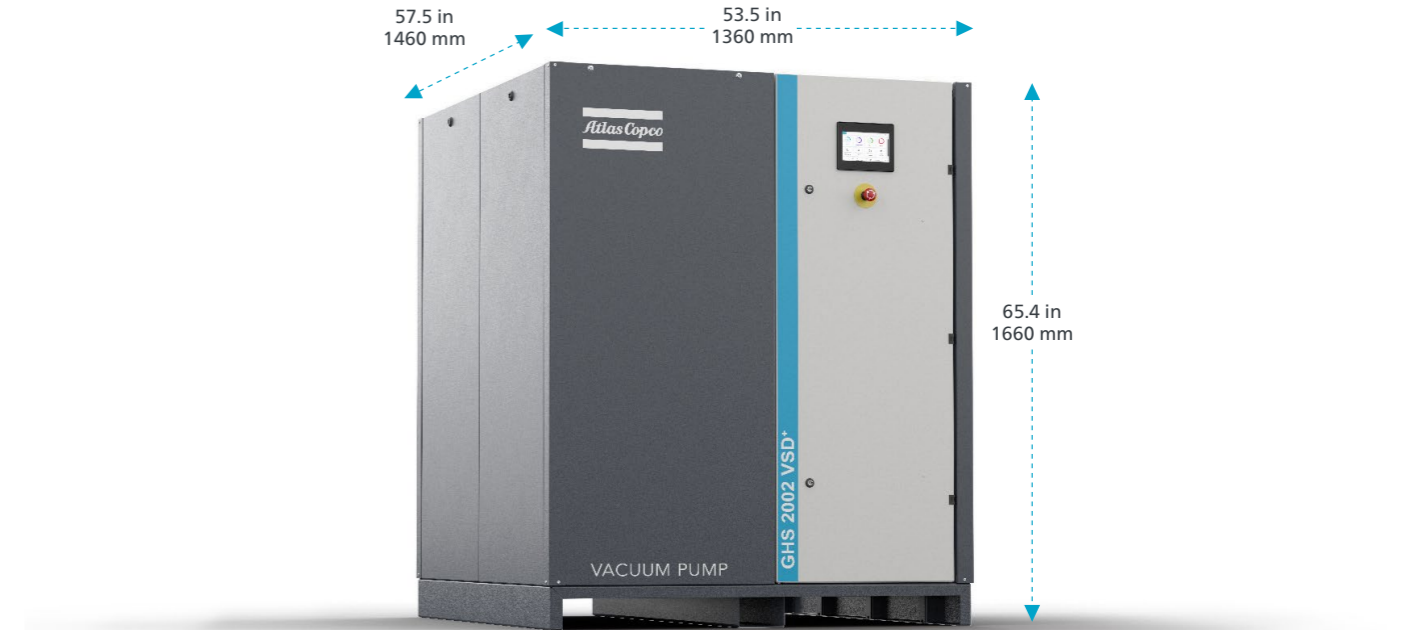

Dimensions	Gas inlet	Gas outlet	Length		Width		Height		Weight	
			mm	in	mm	in	mm	in	kg	lb
GHS 1402 VSD*	DN150	DN125	1460	57.5	1360	53.5	1660	65.4	1180	2602
GHS 1602 VSD*									1190	2624
GHS 2002 VSD*									1200	2646

Service solutions

Preventive Care



Complete service with our Preventive Care plan

We take over the maintenance planning and responsibility for servicing your vacuum pump on a regular basis. Our Preventive Care plan is tailored to your pump's needs. As your pump is serviced with the latest technology, high levels of energy efficiency are achieved. We will also optimize service events to reduce your total cost of ownership and increase your productivity. This allows you to focus fully on your production.



Cost-effective approach

Regular scheduled maintenance can identify potential problems before they occur and plans can be structured around your individual production situation. Preventive Care enables cost management as you can plan your maintenance costs in advance. In this way, expenses associated with unplanned downtime are minimized.



Maximize the lifetime of your vacuum pumps

Our vacuum specialists are well trained and experts in the field. They will help you to improve uptime and protect your processes. Regular maintenance conducted by one of our vacuum specialists reduces the risk of deterioration. Damaged or worn parts will be replaced with genuine Atlas Copco spare parts to protect your investment and increase the lifespan of your vacuum pumps.



Reliability meets non-stop productivity

We use genuine Atlas Copco spare parts and oil and our services are conducted by vacuum specialists according to manufacturer's recommendations. This enhances your vacuum pump performance, reducing the risk of downtime and enabling your production to run more smoothly.



Atlas Copco AB
atlascopco.com/vacuum

