

USE AND MAINTENANCE ISTRUCTIONS  
FOR DRIVEMOT

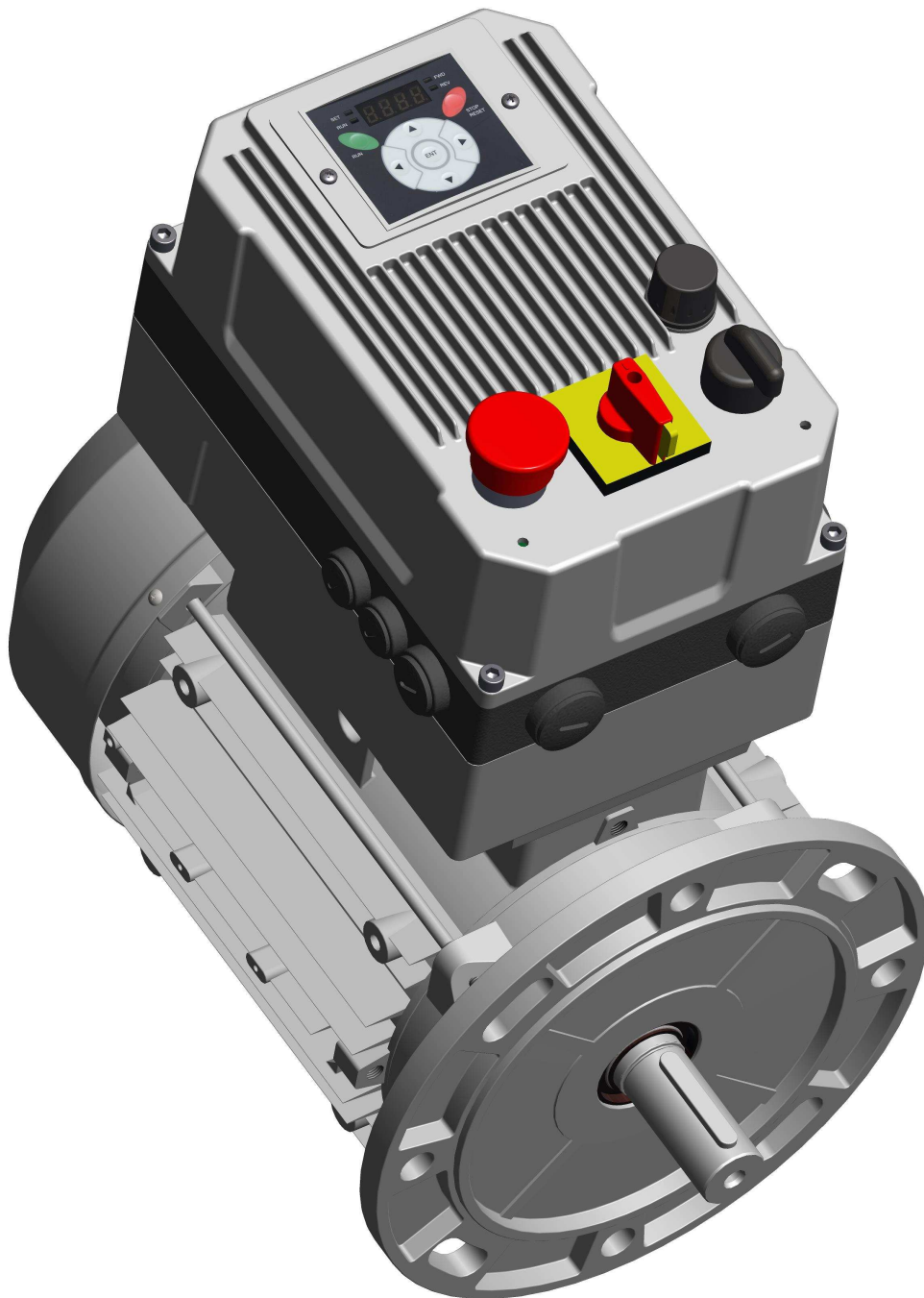



## **WARNING**

*BER-MAR reserves the right to change, at any time, the characteristics of its products to incorporate the latest technological developments. The information contained in this document is subject to change without notice.*

### **WARNING**

**THE DRIVEMOT IS NOT PROVIDED OF A LIFE SAVING DEVICE.  
INSTALLER MUST BE INSTALLING A PROTECTION SWITCH MAGNETIC CIRCUIT  
BREAKERS AS ACCORDING TO THE SPECIFICATIONS REQUIRED BY LAW.**

*In accordance with the EN50178 which concerns the protection of persons the DRIVEMOT must be protected as shown below*

#### **SINGLE PHASE POWER**

*The guard must be by RCD, A type (sensitive to the value of the pulses) or Type B (sensitive to the value of the average current)*

#### **THREE PHASE POWER**

*protection must be provided by the device with RCMA separation (preferred use) or RCD type B (sensitive to the value of the average current)*

*To avoid that the protection intervenes during shutdown of Drivemot is necessary that the tripping current of the circuit breaker is 300 mA or higher.*

*The leakage current to ground may vary according to the load, the length of the motor cables and if used the EMC filter*

*Should be followed by the manufacturer about the electrical connections.*

*Depending on the type of network connection (TN-EN-TT) according to VDE 0100 Part 410 protective further action is necessary.*

*For the network connection type TN must be provided overcurrent protection, with IT connection must be necessary insulation monitoring with measurement method PULSE CODE.*

*In any case may be used protective separation until the length of the power cables installed so permits*

**THE DRIVEMOT IS MANUFACTURED WITH INTERNAL EMC FILTER FOR SUPPRESSION OF ELECTROMAGNETIC INTERFERENCE, THE EMC FILTER CAN MAKE LEAKAGE CURRENT THROUGH THE GROUND**

*For the user's safety, this DRIVEMOT must be connected to a grounded (terminal).*

*If accidentally starting the Drivemot poses a risk the people or the machines that is driven, it is imperative that the device by an isolating device or a switching device (contactor) controlled by an external safety ( emergency stop or fault detector).*

*The DRIVEMOT provides safety devices that may, in the event of a fault, control stopping and thus stop the motor.*

*The motor can be stopped by a mechanical blockage.*

*Cause of drivemot arrest, can be also a voltage variations or power cuts.*

*The removal of the causes of arrest may lead to restarting, which is harmful for certain machines or installations, especially those that must comply with Annex 1 of Decree 92767 of 29 July 1992 on the safety.*

*In such cases it is, therefore, important that the user takes appropriate precautions against the possibility of re-starting in the event of an unscheduled stop of the drivemot.*

*The variable speed drive is designed to power a motor and the driven machine above their rated speed.*

***If the motor or the machine are not mechanically designed to withstand such speeds, the user may be exposed to serious risks due to mechanical wear of the drivemot.***

***Before programming a high speed, it is important that the user checks that the system is able to bear it.***

***The variable speed drive is a component designed to be incorporated in an installation or in an electric machine and, in any case, can be considered as a safety device.***

***It is up to the machine manufacturer, the designer or user to take all necessary measures to comply with the rules in force and provide any devices required to ensure the safety of persons and things.***

***Failure to comply with these provisions, BER-MAR SRL disclaims any liability of any kind ..***



## WARNING

• This symbol indicates the manual, warnings about the consequences resulting from misuse of the DRIVEMOT, to electrical hazards that can result in property damage or personal injury as well as fire hazards.

### 1 - General

According to the degree of protection, the DRIVEMOT may have, during operation, moving parts, and hot surfaces.

Unjustified removal of protection devices, incorrect use, faulty installation or inappropriate operation may cause serious risks to humans, animals and things.

For more information, see the documentation. All operations concerning transport, installation, commissioning and maintenance must be performed by qualified personnel (see IEC 364 or CENELEC HD 384 or DIN VDE 0100 and national specifications for installation and accident prevention).

For the purposes of these basic safety instructions, qualified personnel are persons responsible for the installation, assembly, commissioning and operation of the product, possessing the relevant qualifications for their work.

### 2 - Use

The DRIVEMOT components are intended to be incorporated in installations or electrical machines.

When integrated into a machine, it is prohibited to service until it has been verified that the machine complies with the provisions of Directive 89/392/EEC (Machinery Directive).

To comply with standard EN 60204, which provides, inter alia, that electrical actuators (which includes the DRIVEMOT) can not be considered as a circuit-breaking devices and certainly not as isolating switches.

Their commissioning is possible only if you comply with the provisions of the Electromagnetic Compatibility Directive (89/336/EEC, as amended by 92/31/EEC). The DRIVEMOT comply with the requirements of the Low Voltage Directive 73/23/EEC, amended by 93/68/EEC. Apply the harmonized standards of the DIN VDE 0160 with standard VDE 0660, part 500 and EN 60146 / VDE 0558.

It is imperative that the specifications and instructions concerning the connection conditions shown on the nameplate and in the documentation provided.

### 3 – Electic connections

•• All connection work must

be made in accordance with the laws in force in the country of installation. This is to ensure that no part of the drive can be directly accessible to the mains voltage or any other potentially hazardous voltage (including earth or ground).

### 5 – Mechanical Installation

The installation and cooling of equipment must comply with the requirements of the documentation provided with the product.

The DRIVEMOT must be protected from excessive stress. In particular, during transport and handling, there must be no damage to parts and / or changes of the clearance between the components. Avoid touching electronic components and contacts.

The DRIVEMOT contain parts which are sensitive to electrostatic discharge and are easily damaged if handled incorrectly. Electrical components must not be mechanically damaged or destroyed (otherwise, risk of injury).

### THE INSTALLATION

It is up to the owner or you ensure that the installation, operation and maintenance of the inverter and its options are carried out in compliance with the legislation on the safety of people, animals and things and regulations in force in the country in which it is used.

· Do not carry out any work, disconnect and lock the drive power supply and without, wait 2 minutes for the capacitors to discharge the single-phase range.

· After connecting, for watertight IP 65, check that the gaskets are correctly placed and that the screws and cable clamps are tight. Clear the holes drain water from condensation at low points in the engine.

### 5 - Electrical installation

When work is performed on DRIVEMOT in power, you must comply with the requirements of national injury prevention.

The electrical installation must be carried out in accordance with the applicable requirements (for example, sections of conductors, protection, internal connection of the protective conductor). In the documentation, are given more detailed information. Instructions for an installation which meets the requirements for electromagnetic compatibility, such as shielding, grounding, presence of filters and correct insertion of cables and conductors) are reported in the literature accompanying the DRIVEMOT. These instructions must be followed in all cases, even when the DRIVEMOT carries the CE mark.

Compliance with the limits given in the EMC legislation is the responsibility of the manufacturer of the installation or machine.

### 6 - Operation

Installations incorporating the DRIVEMOT must be fitted with additional protection and monitoring required by safety regulations in force, eg the law on technical equipment, regulations for prevention of accidents, etc. ... are permitted changes DRIVEMOT by the control software.

After disconnecting the DRIVEMOT, Active parts of the voltage and power connections must not be

- The voltages on the cables or network connections, motor, braking resistor or the filter may result in fatal electric shocks. Contact must be avoided in any case.
- To disconnect the power safely, the drive must be powered by inserting a cut-off device.
- The drive contains capacitors that, even after the power outage, remain charged in a fatal voltage.
- After stopping the drive power supply, wait 2 minutes for the internal circuitry may discharge the capacitors before removing the covers.
- The drive power supply must be protected against overloads and short circuits
- It is vital to respect the protections.
- Use copper conductors only.
- Check the compatibility of the voltage and current between the drive, motor and network.
- After the operation, the heatsink of the drive is hot, avoid contact.

### 3.1 - Wiring Precautions

- When the DRIVEMOT is controlled remotely, avoid parallel the power cables and the control cables. - All cable remote control must be shielded and have a cross section of 0.22 mm<sup>2</sup> and 1 mm<sup>2</sup>. The shield must be connected to earth at two ends.

- The DRIVEMOT is configured in positive logic. Using a drive with an automatic with a different control logic may cause unexpected restart of the motor.
- In the drive, the control circuits are isolated from the power circuits with single insulation (IEC 664-1). The installer must ensure that the external control circuits are insulated in order to avoid any contact with the people.
- If the control circuits must be connected to the circuits comply with SELV safety requirements, to maintain the SELV classification, you must use additional insulation.

### 4 - Transportation, storage

It is essential to follow the instructions for transport, storage and proper handling. Must comply with the conditions specified in the technical manual.

touched immediately as the capacitors may still be charged. In view of this, the warnings affixed DRIVEMOT.

During operation, all the protections must remain in their place.

### 7 - Wiring the Ground

The 0V of the control terminals is connected to the mass of the body. Check the conformity of the grounding DRIVEMOT. Check that the voltage between phases and earth is balanced. If the ground is not compliant, the DRIVEMOT risk of "safety stops". In this case, remove the green / yellow wire coming out of the drive (with the wires black, red and white) and connect the ground directly to the motor housing and not on the PE terminal of the power terminals.

If you do this rewiring, the integrated filter is no longer active and the DRIVEMOT no longer complies with the EMC directive (§ 1.5.2).

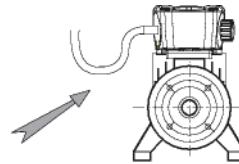

- Route the cables to the cable with a radius of curvature which prevents water penetration.
- Tighten the cable gland ..

### 8 - Servicing and maintenance Refer to manufacturer's documentation.

## GROUND CONNECTION DETAILS

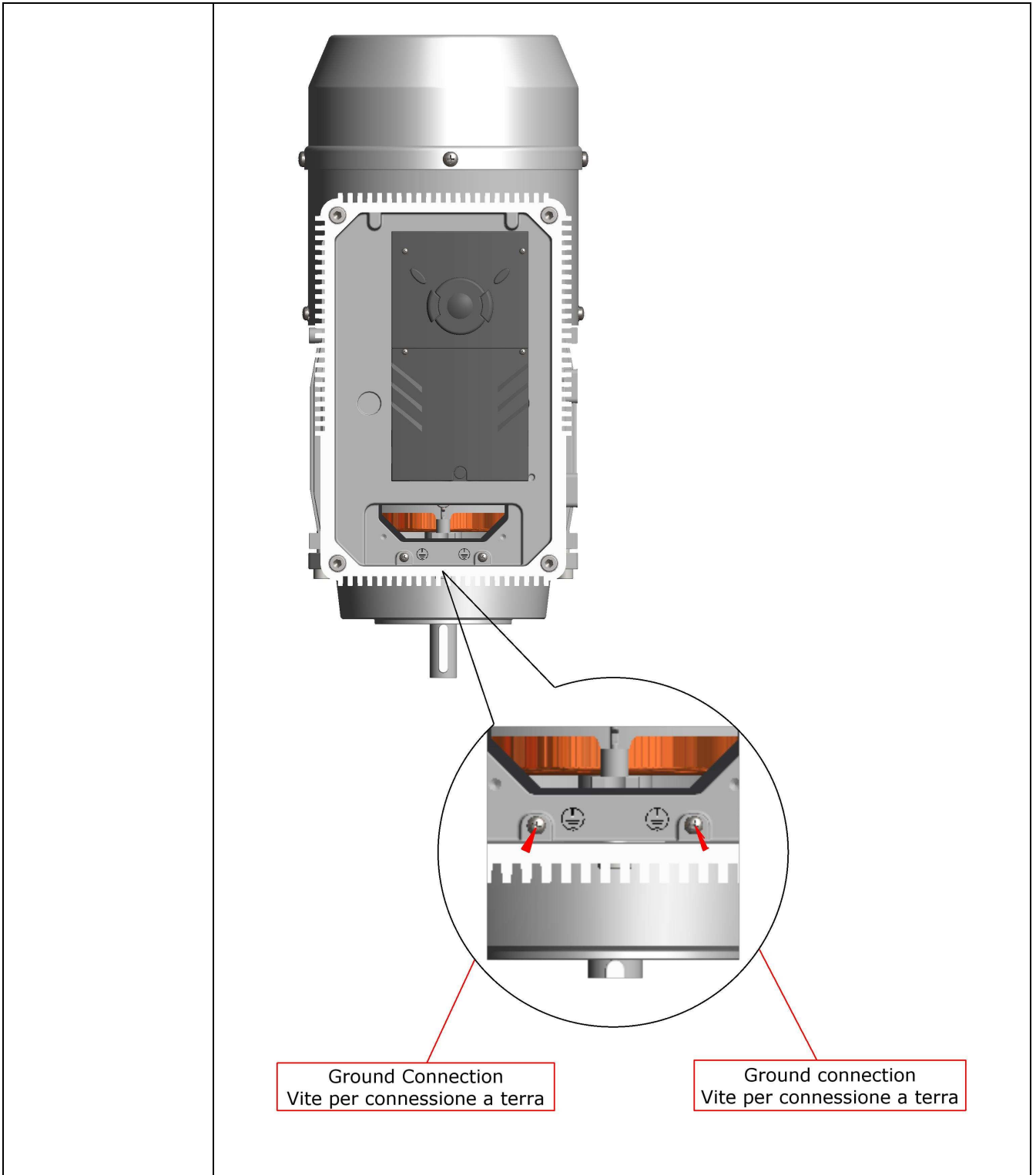

## KEY-PAD DETAILS

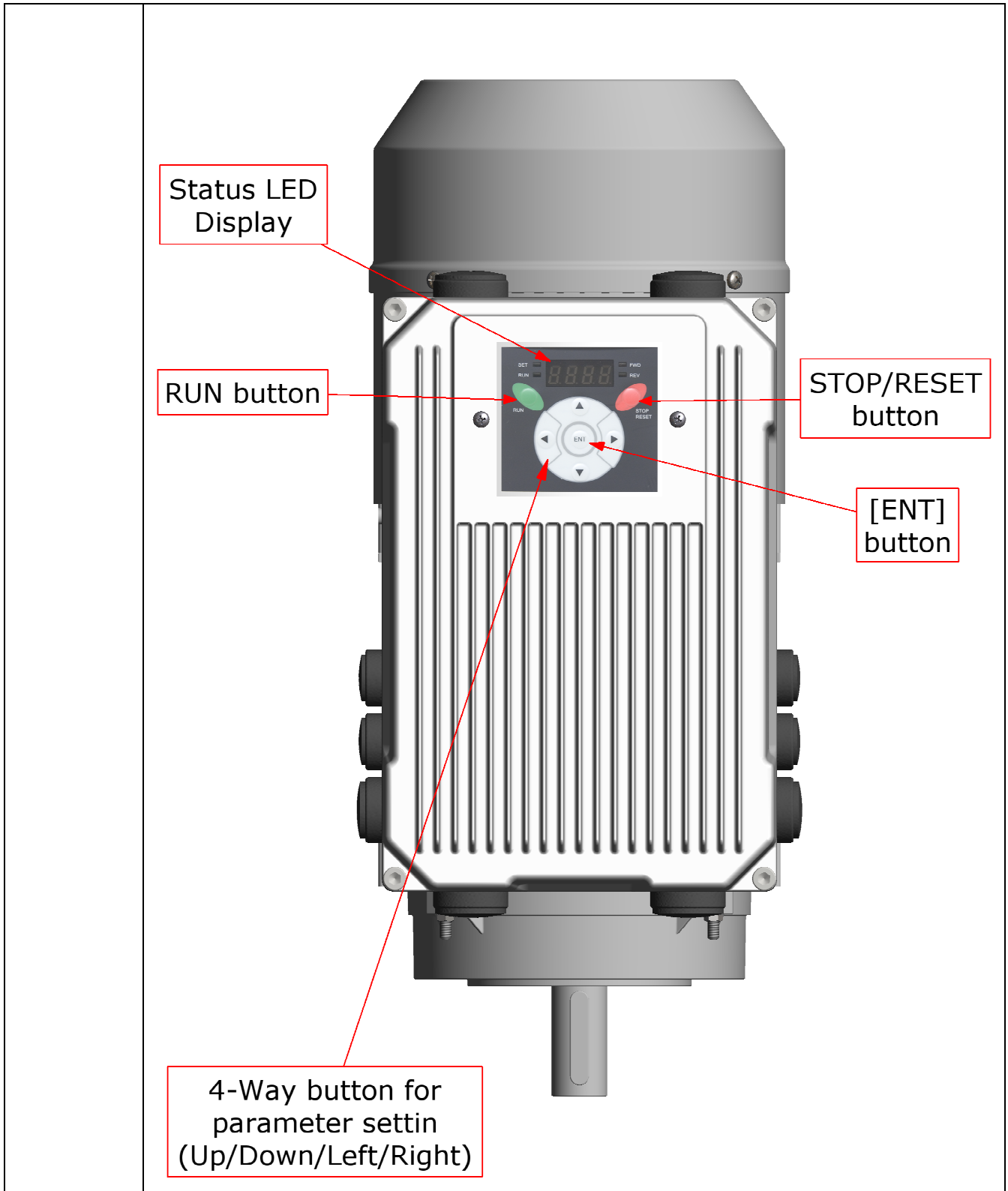

## STANDARD DRIVEMOT WITH COMMAND ON BOARD

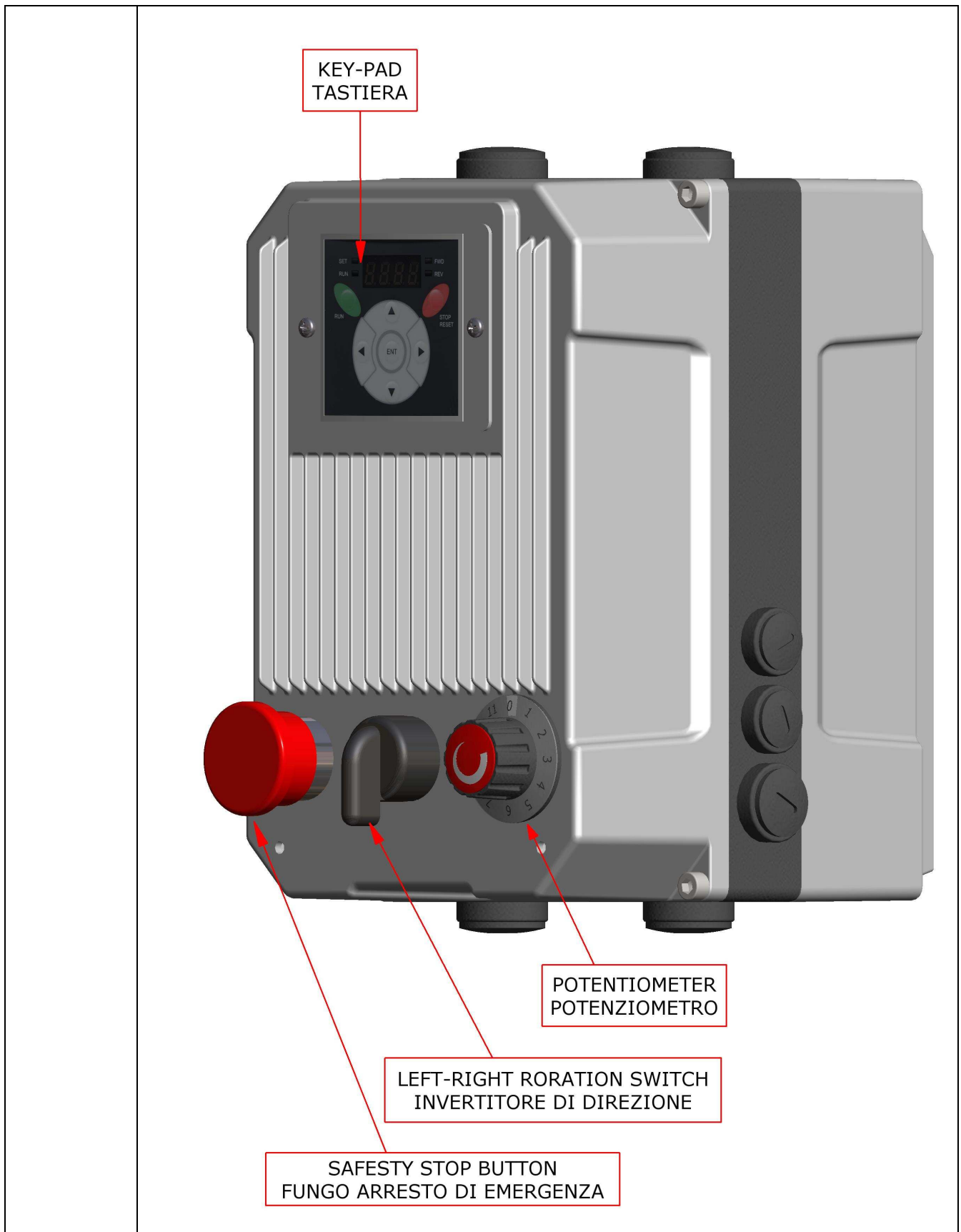



# STANDARD DRIVEMOT CONSTRUCTION DETAILS

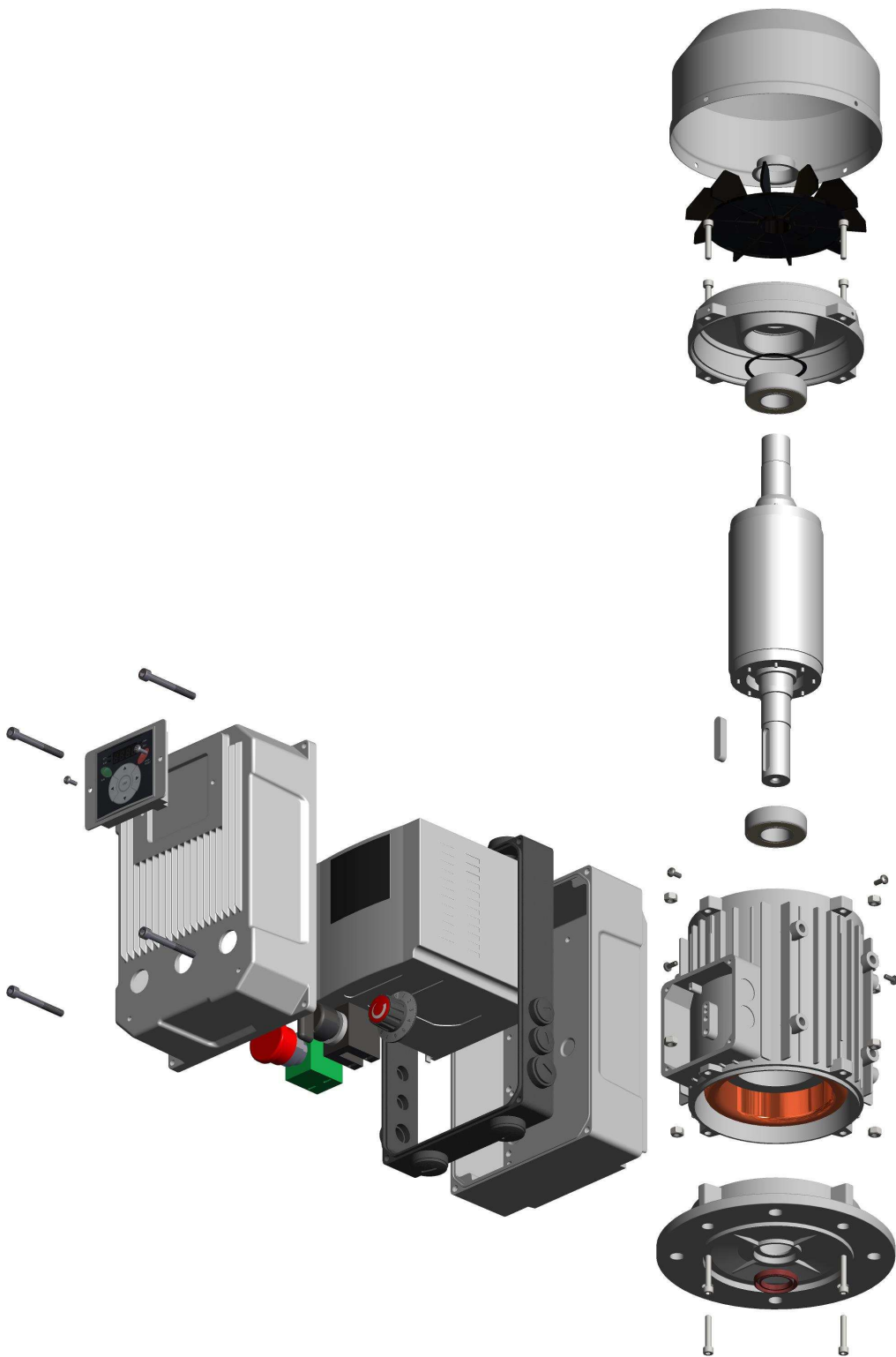

# DRIVEMOT CONSTRUCTION WITH BRAKE AND FORCED VENTILATION

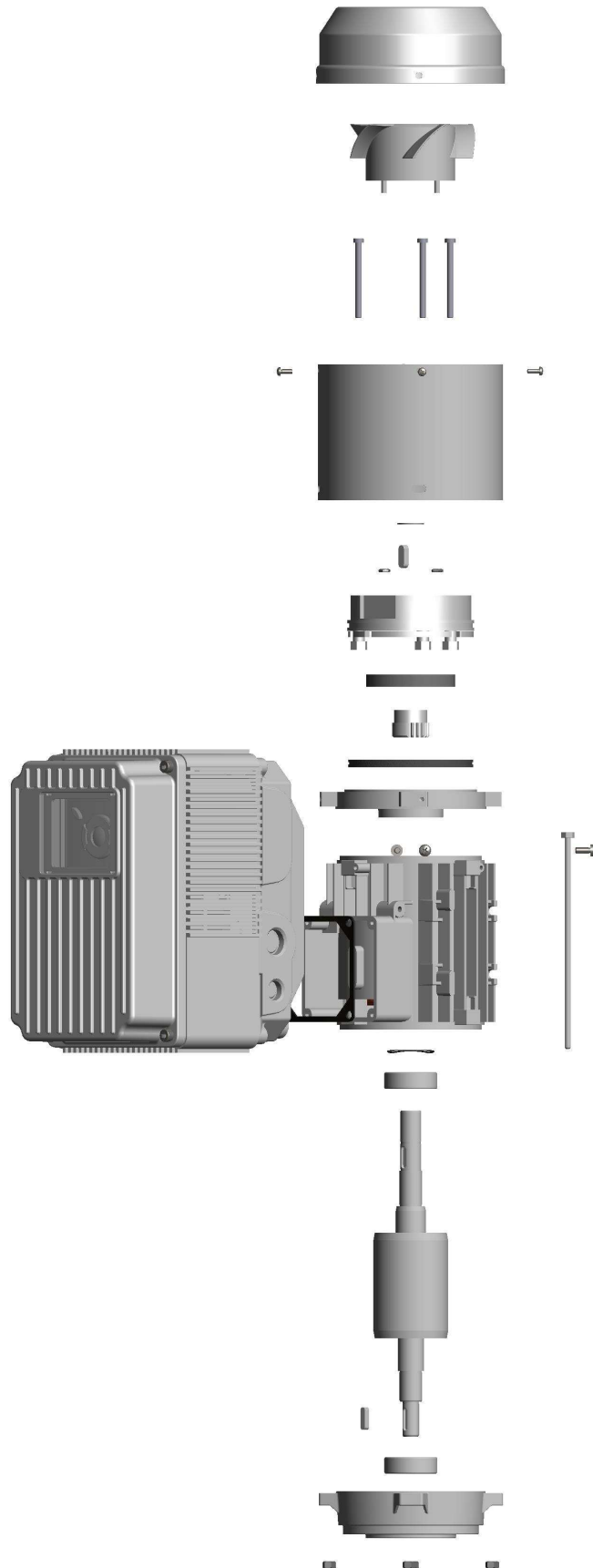



## SAFETY INSTRUCTIONS

- Always follow safety instructions to prevent accidents and potential hazards from occurring.
- In this manual, safety messages are classified as follows:



### WARNING

Improper operation may result in serious personal injury or death.



### CAUTION

Improper operation may result in slight to medium personal injury or property damage.

- Throughout this manual we use the following two illustrations to make you aware of safety considerations:



Identifies potential hazards under certain conditions.

Read the message and follow the instructions carefully.



Identifies shock hazards under certain conditions.

Particular attention should be directed because dangerous voltage may be present.

- Keep operating instructions handy for quick reference.
- Read this manual carefully to maximize the performance of SV-iG5A series inverter and ensure its safe use.



## WARNING

- **Do not remove the cover while power is applied or the unit is in operation.**  
Otherwise, electric shock could occur.
- **Do not run the inverter with the front cover removed.**  
Otherwise, you may get an electric shock due to high voltage terminals or charged capacitor exposure.
- **Do not remove the cover except for periodic inspections or wiring, even if the input power is not applied.**  
Otherwise, you may access the charged circuits and get an electric shock.
- **Wiring and periodic inspections should be performed at least 10 minutes after disconnecting the input power and after checking the DC link voltage is discharged with a meter (below DC 30V).**  
Otherwise, you may get an electric shock.
- **Operate the switches with dry hands.**  
Otherwise, you may get an electric shock.
- **Do not use the cable when its insulating tube is damaged.**  
Otherwise, you may get an electric shock.
- **Do not subject the cables to scratches, excessive stress, heavy loads or pinching.**  
Otherwise, you may get an electric shock.



## CAUTION

- **Install the inverter on a non-flammable surface. Do not place flammable material nearby.**  
Otherwise, fire could occur.
- **Disconnect the input power if the inverter gets damaged.**  
Otherwise, it could result in a secondary accident and fire.
- **After the input power is applied or removed, the inverter will remain hot for a couple of minutes.**  
Otherwise, you may get bodily injuries such as skin-burn or damage.
- **Do not apply power to a damaged inverter or to an inverter with parts missing even if the installation is complete.**  
Otherwise, electric shock could occur.
- **Do not allow lint, paper, wood chips, dust, metallic chips or other foreign matter into the drive.**  
Otherwise, fire or accident could occur.

## OPERATING PRECAUTIONS

### (1) Handling and installation

- Handle according to the weight of the product.
- Do not stack the inverter boxes higher than the number recommended.
- Install according to instructions specified in this manual.
- Do not open the cover during delivery.
- Do not place heavy items on the inverter.
- Check the inverter mounting orientation is correct.
- Do not drop the inverter, or subject it to impact.
- Follow your national electrical code for grounding. Recommended Ground impedance for 200 V Class is below 100 ohm and for 400V class below 10 ohm.
- iG5A series contains ESD (Electrostatic Discharge) sensitive parts. Take protective measures against ESD before touching the pcb for inspection or installation.
- Use the inverter under the following environmental conditions:

|             |   |  |
|-------------|---|--|
| Environment | Ambient temperature   | - 10 ~ 50 °C (non-freezing)  |
|             | Relative humidity   | 90% RH or less (non-condensing)  |
|             | Storage temperature   | - 20 ~ 65 °C   |
|             | Location  | Protected from corrosive gas, combustible gas, oil mist or dust        |
|             | Altitude, Vibration  | Max. 1,000m above sea level, Max. 5.9m/sec <sup>2</sup> (0.6G) or less |
|             | Atmospheric pressure  | 70 ~ 106 kPa   |

### (2) Wiring

- Do not connect a power factor correction capacitor, surge suppressor, or RFI filter to the output of the inverter.

- The connection orientation of the output cables U, V, W to the motor will affect the direction of rotation of the motor.
- Incorrect terminal wiring could result in the equipment damage.
- Reversing the polarity (+/-) of the terminals could damage the inverter.
- Only authorized personnel familiar with LS inverter should perform wiring and Inspections.
- Always install the inverter before wiring. Otherwise, you may get an electric shock or have bodily injury.

### (3) Trial run

- Check all parameters during operation. Changing parameter values might be required depending on the load.
- Always apply permissible range of voltage to the each terminal as indicated in this manual. Otherwise, it could lead to inverter damage.

### (4) Operation precautions

- When the Auto restart function is selected, stay away from the equipment as a motor will restart suddenly after an alarm stop.
- The Stop key on the keypad is valid only when the appropriate function setting has been made. Prepare an emergency stop switch separately.
- If an alarm reset is made with the reference signal present, a sudden start will occur. Check that the reference signal is turned off in advance. Otherwise an accident could occur.
- Do not modify or alter anything inside the inverter.
- Motor might not be protected by electronic thermal function of inverter.
- Do not use a magnetic contactor on the inverter input for frequent starting/stopping of the inverter.
- Use a noise filter to reduce the effect of electromagnetic interference. Otherwise nearby electronic equipment may be affected.
- In case of input voltage unbalance, install AC reactor. Power Factor capacitors and generators may become overheated and damaged due to potential high frequency noise transmitted from inverter.
- Use an insulation-rectified motor or take measures to suppress the micro surge voltage when driving 400V class motor with inverter. A micro surge voltage attributable to wiring constant is generated at motor terminals, and may deteriorate insulation and damage motor.
- Before operating unit and prior to user programming, reset user parameters to default settings.
- Inverter can easily be set to high-speed operations, Verify capability of motor or machinery prior to operating unit.
- Stopping torque is not produced when using the DC-Break function. Install separate equipment when stopping torque is needed.

### (5) Fault prevention precautions

- Provide a safety backup such as an emergency brake which will prevent the machine and equipment from hazardous conditions if the inverter fails.

(6) Maintenance, inspection and parts replacement

- Do not conduct a Megger (insulation resistance) test on the control circuit of the inverter.
- Refer to Chapter 14 for periodic inspection (parts replacement).

(7) Disposal

- Handle the inverter as an industrial waste when disposing of it.

(8) General instructions

Many of the diagrams and drawings in this instruction manual show the inverter without a circuit breaker, a cover or partially open. Never run the inverter like this. Always place the cover with circuit breakers and follow this instruction manual when operating the inverter.

### **Important User Information**

- The purpose of this manual is to provide the user with the necessary information to install, program, start up and maintain the SV-iG5A series inverter.
- To assure successful installation and operation, the material presented must be thoroughly read and understood before proceeding.



Directions on safety measures and special instructions for single and three phase asynchronous electric motors and special execution.

Carefully read the instructions before performing any movement, transportation, installation, operation, maintenance or repair of electric motors.

The symbology shown, is the reference to security measures and additional instructions given in this manual.

|  |   |
|--|---|
| <i>Safety instructions and warranty:</i> |  |
| <i>Instruction and Warning Signs:</i>    |  |

Follow all safety precautions and instructions of this manual, in order to prevent any accident and personal injuries to people and/or property and the preservation of the environment.



|   |   |
|---|---|
|    | <p>Electrical machines, single and three phase induction motors, fed with low voltage, contain rotating parts in motion, and they can reach the outer surface (casing) at high temperatures. Improper use of electric motors can cause damage to persons or property, and produce damage to the environment.</p>  |
|  | <p>All the movement, transport, installation, <b>operation</b>, maintenance or reparation operations must be performed by qualified personnel and supervised by responsible. ( IEC 364 e VDE 0105)<br/>         Improper use of electric motors (almost-machines) can cause damage to person, property and the environment. The electrical machines must be installed and operated by qualified personnel</p> |

|   |  |
|---|--|
|  | <p><b>1) General Instructions</b><br/>         Three phase and Single phase standard electric motors series are in conformity with provisions of the harmonised Standard EN60034-1 and comply with provisions of Low Voltage Directive 73/23/EEC (amended by Directive 93/68/EEC). (revised by 93/68/EEC). By design, the electric motors considered as components almost - machine, comply with the essential requirements of:<br/>         *Machinery Directive 98/37/EEC provided that the installation be correctly realised by the manufacturer of the machinery (for example: in compliance with our installation instructions and EN60204 "Electrical Equipment of Industrial Machines");<br/>         *EMC Directive 89/336/EEC (amended by 92/31/EEC and 93/68/EEC) regarding the intrinsic characteristics to emission and immunity levels.<br/>         All standard electric motors supplied from the line and running in continuous duty comply with standards EN50081 (emission levels for civil environments) and EN50082 (immunity for industrial environments);</p> |
|---|--|

|   |   |
|---|---|
|  | <p>All electric motors, considered as components, are designed to be incorporated into equipment or complete systems and should not put into service before equipment or system has been made in conformity with Machine Directive (Certificate of Incorporation – Directive 2006/42/CE).<br/>         The responsibility of the compliance with the Machinery Directive and EMC Directive for a complete installation is of the machine manufacturer.<br/>         Please read these instructions carefully before using the motor; all operations related to the installation, putting into service, maintenance and protection of the electric motor must be carried out by qualified persons in full observance of all legal requirements and applicable technical standards, as well the safety prescriptions of the EN60201-1 standards</p> |
|---|---|

governing electrical equipment for machinery. This documentation integrates and does not substitute any legal requirements, technical standards or safety prescriptions applicable to the use and maintenance of the electric motor.  
The manufacturer accepts no liability for accident or damage resulting from improper use or failure to adhere to applicable EU standards governing the safety of electric motors. Pay particular attention to the indications on the label. The conditions of use must match the nameplate data over the general instructions of this manual

**2) TRANSPORT AND MOTION**  
Damages of any kind occurred at the time of delivery must be immediately reported to the Transport Company. Do not proceed with the operation of electric motors found damaged. Move electric motors with attention to weight, in accordance with Art 167 e segg. D.lgs 03/08/2009 n 106 conversione in D.Lgs 09/04/2008 n 81, as applicable.  
Only use the eyebolts, when applied to the machine and specially designed for lifting. Use appropriate means.



  
**3) MECHANICAL INSTALLATION**  
Before installation, verify that:  
the electric motor is not visually damaged (damage caused by transport or storage);  
the conditions of use and intended application correspond to the indications given on the nameplate;  
the supply voltage is the same as network voltage;  
the admitted voltage is 230/400V±10% 50Hz - 460V±10% 60Hz (±5% for other voltages and/or singlephase motors);  
the ambient temperature is between -20°C e +40°C; the altitude is <1000 meters above sea level; different conditions of ambient temperature and/or higher altitudes implies a corrective factor of the power;  
the relative humidity is <90% for electric motor in TROP1;  
tropicalisation TROP2 for the relative humidity >90% and/or ambient with high thermal excursion with the possibility of condensation;  
the IP rating indicated on the motor is suitable for the ambient conditions in accordance with IEC34-5. The motor is lifted by the points provided; eyebolts on motors are suitable only for lifting the motor and not other machines fitted to it;  
the components that should be connected to the electric motor are in conformity with electric motor data.



**4) PRELIMINARY OPERATIONS**  
Remove all fasteners or protections used for the transport (ex. output shaft cover) and verify that the motor shaft rotate freely;  
in order not to damage them; verify that the motor has not absorbed humidity, in particular after a long storage, by measuring that the insulation resistance is < 10MW a 20°C; to carry out this measure use a 500V direct voltage from motor phases to earth;  
the windings must be discharged immediately after the measure.  
If the insulation resistance is not sufficient the motor must be dried with warm air or through an insulation transformer by connecting in series the windings of each phase and applying an auxiliary alternate voltage equal to 10-20% of the nominal voltage, in order to obtain a sufficient resistance.



**5) MOTOR INSTALLATION**  
It's recommended to fix the electric motor adequately according to earth, type of assembly and mounting position; carry out the assembly of the motor on flat, rigid and vibrations-free base and resistant to the deformations; align with care the motor and the machine to avoid stress not admitted on the motor shaft, observing radial and axial loads; a misalignment or a forced keying can cause, during running, anomalous overheating that could endanger safety; in case of vertical installations, be careful that nothing falls inside of the ventilators; during the assembly, in order to avoid damages to the bearings, use the motor shaft as support, but previously ~~dismount the fan cover~~.





|   |  |
|---|--|
|  | <p>previously dismount the fan cover;<br/>do not strain or bump the motor end-shaft;<br/>the motor must be installed in a suitable position to allow:<br/>the possibility to read data written on the nameplate, inspection of the terminal box;<br/>internal cleaning of the motor; protection of the external components from moving parts (ex. fan cover); an adequate ventilation, avoiding any obstruction to the air intakes and the entrance of swarf, dust or liquids and all the situations that can cause overheating; if the motor is used in an ambient with excessive humidity, the terminal box should be set in order that entrance of the cables is placed downward; please verify that there isn't any condensation; if there are condensate drainage holes, remove the plastic plugs to eliminate any possible condensate then replace plugs to restore IP protection degree; carry out this operation only after having disconnected the power supply;<br/>If the motor is equipped with anti-condensation heaters, it is important to ensure that these are not powered when the motor is running, verify that the voltage of the anti-condensation heaters is in accordance with the specified voltage.</p> |
|---|--|



|   |   |
|---|---|
| <br> | <p><b>6) ELECTRIC INSTALLATION AND USE</b><br/>Connect the motor to the supply mains following the wiring diagram inside the terminal box; Do not connect or start the motor without the wiring diagram; do not start the motor with free key. Before connection, check that the motor cables are correctly tightened on the terminal board;<br/>for the wiring take all the small items from the envelop supplied with motor and proceed with the installation, the cable terminal used for the wiring of the supply cable must be insulated type in order to grant the minimum distances between live parts and not active metallic parts. The selection of the cable gland depends on the external dimension of the cabled employed; all the cables entrances not used must be sealed in order to restore IP protection degree written on the nameplate. The supply cables and the grounding cables must comply with the standards, please select .cables and conductors suitable for the required capacity and insulation;<br/>the wiring of connections and cables section must comply with EN60204-1;</p> |
|---|---|

|  |   |
|--|---|
| <br> | <p><b>7) GROUNDING INSTALLATION</b><br/>All motors are suitable for the grounding, inside the terminal box and outside on the motor casing;<br/>earth terminal are marked with a symbol (ground).<br/>To fix earth cable please try to avoid any loosening.<br/>Before the start - up verify the direction of the motor rotation;<br/>If the motor has to rotate in the opposite direction, for the three-phase electric motors it is enough to change 2 phases, for single phase electric motors follow the wiring diagram.<br/>The rotation direction is clockwise when viewed from the output shaft end of the motor, opposite to the fan side.<br/>If there is a backstop device, don't start the motor in the opposite direction; for checking reasons, the backstop device can be starter only one time in the opposite direction with a half voltage respect to the nominal supply voltage of the electric motor. After wiring operation, re-assemble the terminal box and its basket with accuracy. Don't touch the enclosure of the motor when it's running as the operative temperature may reach values in excess of &gt; 50°.</p> |
|--|---|

|  |  |
|--|--|
| <br> | <p><b>8) PROTECTION FOR ELECTRIC MOTOR</b><br/>All electrical circuit must be protected against damage resulting from faults or malfunction due to: short circuit overloads, overload current, interruption or reduction of the supply voltage. Excessive speed of machinery components, overheating in case of a high number of on-load starts. For the safety of persons and/or objects, protections must be provided against direct contact with live parts and indirect contact with parts which are not live under normal conditions but which may become so in the event of a fault.<br/>If the motor shaft stop because of a cutoff, it is recommended to take precautions for the stop of the rotation in the opposite direction; if the safety machine depends on the sense of direction of the motor shaft, it's recommended to take precautions to avoid an inversion of the phases; in case the sense of direction must be indicated with a visible label.</p> |
|--|--|

|   |  |
|---|--|
|  | <p><b>9) SAFETY REGULATIONS</b></p> <p><b>NOISE EMISSIONS</b><br/> Three-phase and single-phase standard electric motors series fall in the Normative D.Lgs 195 of 10/04/2006 n. 195 for the regulation of noise emission and noise pollution as falling within the noise level than 80dB pressure.</p> <p><b>VIBRATIONS</b><br/> The electric motors are considered almost – machine: the vibration valuation has to be done by the final constructor, falling within the referent directive, considering as follow: the vibrations emitted by the single electric motor, fall within the parameters as provided in the Law 187 of 19/08.</p> |
|---|--|

|   |   |
|---|---|
|  | <p><b>10) MAINTENANCE</b></p> <p>Before maintenance on the electric motors or nearby areas, switch off the power supply on both the motor and the brake and make sure that no accidental connection happens; wait till all moving parts have stopped; wait that the surface temperature is lower than 50°C before touching the motor, in order to avoid any possible burn. Periodically verify that there isn't any excessive dust, there isn't any oil deposit, dirt on the fan or fan cover that can compromise the correct cooling, the conditions of the oil seal and the tightening of the connections, there isn't any vibration or noise. Any unauthorised disassembly of components will invalidate the warranty and release the builder from all liability (law 187 of 19/08).</p> |
|---|---|

|   |  |
|---|--|
| <br> | <p><b>Any operation whatsoever on the motor must only be carried out with the machine stopped and disconnected from the power supply, including auxiliary circuits.</b></p> <p>At regular intervals check if the motor is operating correctly and within its specifications with no abnormal noise or vibration and that the ventilation air inlet is not blocked. The inspection and maintenance intervals depend on the actual operating conditions (loads, number of starts, a.s.o.) and the ambient conditions (dust, a.s.o.).</p> <p>As a result no more than general guidelines can be supplied. The normal version of the motors is provided with the bearings of the size shown in table 2. The type of bearing can change in special versions of the motor.</p> <p>You can check which type of bearing has been used from the code stamped on the side edge of the outer ring of the bearing itself. The bearings used on the standard version on motors from size 56 up to size 160 are life lubricated maintenance-free designs. Under normal operating conditions the grease packed in the bearings is sufficient for several years. The bearings used on the standard version on motors from size 180 up to size 315 are open type and therefore the motors are provided with lubricators. For recommended intervals of bearing lubrication see table 4. It is good practice to change the bearings every 3 years.</p> <p>Use an extractor to remove the bearings. Heat the bearings (to approximately 80 °C) to make them easier to fit. <b>Never hit the bearings</b> with a hammer to avoid damaging them. when changing the bearings it is good practice to also change any seal rings on the shaft, lightly greasing the slip zone of the seal lip.</p> <p>Make sure that the various different parts are assembled in the correct order when disassembling and reassembling the motor (marking the different parts during disassembling if necessary). Pay particular care to avoid damaging the windings when sliding the rotor out from the stator.</p> |
|---|--|

|   |  |
|---|--|
|  | <p><b>WARNING:</b><br/> <b>never operate the motor without coupling unit without fixing or removing the key.</b></p> <p>It is recommended to always use original spare parts.<br/> The producer will not be responsible for damage by improper use of the motor, non-compliance with periodic/maintenance/replacement prescriptions and use of non-original parts.<br/> Disassembly of the motor to dispute, even if partial, is prohibited.</p> <p>Delivered motors may differ in details from those described.</p> |
|---|--|

**Table 2: Bearings installed on aluminium motors**



| Frame | Poles   | Drive Bearing | Rear Bearing |
|-------|---------|---------------|--------------|
| 56    | 2-4-6   | 6201 zz C3    | 6201 zz C3   |
| 63    | 2-4-6-8 | 6202 zz C3    | 6202 zz C3   |
| 71    | 2-4-6-8 | 6203 zz C3    | 6203 zz C3   |
| 80    | 2-4-6-8 | 6204 zz C3    | 6204 zz C3   |
| 90    | 2-4-6-8 | 6205 zz C3    | 6205 zz C3   |
| 100   | 2-4-6-8 | 6206 zz C3    | 6206 zz C3   |
| 112   | 2-4-6-8 | 6306 zz C3    | 6206 zz C3   |
| 132   | 2-4-6-8 | 6308 zz C3    | 6208 zz C3   |
| 160   | 2-4-6-8 | 6309 zz C3    | 6309 zz C3   |

**Table 2.1: Bearings installed on cast-iron motors**



| Frame | Poles   | Drive Bearing | Rear Bearing |
|-------|---------|---------------|--------------|
| 180   | 2-4-6-8 | 6311 C.3      | 6311 C.3     |
| 200   | 2-4-6-8 | 6312 C.3      | 6312 C.3     |
| 225   | 2       | 6313 C.3      | 6313 C.3     |
| 225   | 4-6-8   | 6313 C.3      | 6313 C.3     |
| 250   | 2       | 6314 C.3      | 6314 C.3     |
| 250   | 4-6-8   | 6314 C.3      | 6314 C.3     |
| 280   | 2       | 6314 C.3      | 6314 C.3     |
| 280   | 4-6-8   | 6317 C.3      | 6317 C.3     |
| 315   | 2       | 6316 C.3      | 6316 C.3     |
| 315   | 4-6-8   | NU319         | 6319 C.3     |

**Table 4: Recommended intervals (hours) for bearings lubrication**

**When the working frequency is over 60Hz reduce the recommended intervals of 20%**



| Bearing Type | 2 poles motor | 4 poles motor | 6 poles motor | 8 poles motor | Substitution |
|--------------|---------------|---------------|---------------|---------------|--------------|
| 6201 zz C3   | 30.000        | 35.000        | 40.000        | 40.000        | over 50.000  |
| 6202 zz C3   | 30.000        | 35.000        | 40.000        | 40.000        | over 50.000  |
| 6203 zz C3   | 25.000        | 25.000        | 30.000        | 30.000        | over 40.000  |
| 6204 zz C3   | 20.000        | 25.000        | 30.000        | 30.000        | over 40.000  |
| 6205 zz C3   | 20.000        | 25.000        | 30.000        | 30.000        | over 40.000  |
| 6206 zz C3   | 15.000        | 25.000        | 30.000        | 30.000        | over 40.000  |
| 6206 zz C3   | 15.000        | 25.000        | 30.000        | 30.000        | over 40.000  |
| 6207 zz C3   | 13.000        | 20.000        | 25.000        | 25.000        | over 30.000  |
| 6309 zz C3   | 10.000        | 15.000        | 20.000        | 20.000        | over 25.000  |

GREASE: SKF LGHT 3 or SHELL ALVANIA.3 or ESSO BEACON 3 or corresponding

| Bearing Type | 2 poles motor | 4 poles motor | 6 poles motor | 8 poles motor | Grease Grams |
|--------------|---------------|---------------|---------------|---------------|--------------|
| 6309 C.3     | 4500          | 9800          | 13000         | 15500         | 20           |
| 6311 C.3     | 4300          | 9500          | 12700         | 15300         | 25           |
| 6312 C.3     | 3800          | 9300          | 12400         | 15200         | 25           |
| 6313 C.3     | 3100          | 8900          | 12200         | 14800         | 30           |
| 6314 C.3     | 1100          | 4100          | 5900          | 6900          | 30           |
| 6317 C.3     | 800           | 3900          | 5600          | 6700          | 40           |
| 6319 C.3     | 800           | 2300          | 4100          | 5100          | 50           |
| NU319 C.3    | 800           | 2300          | 4100          | 5100          | 50           |

GREASE: SKF LGHT 3 or SHELL ALVANIA.3 or ESSO BEACON 3 or corresponding



### 11) STORAGE

Motors must be stored in mild, dry and clean ambient, under shelter and without vibrations and/or bumps. Shaft ends must be protected with anticorrosive paint or grease, avoiding any contact of these substances with the oil seal



### 12) ASSISTANCE

Warranty right is valid for 12 months from the date of purchase; this right is not recognized in case of evident damages and deteriorations and disassembly of components not authorized. User and/or fitters of electric motors must be informed about these instructions by the customers.

If necessary please contact :

BER-MAR S.r.l. Via C.Bassi 28/a 40015 San Vincenzo di Galliera, Bologna, Italy.

In order to consult technical datas, visit our web- site: <http://www.bermar.it>, any news and information can be provided by our technicians.

### ***Power Diagram connection:***



| Capacity 0.4kW ~ 1.5kW |   |    |    |    |   | Capacity 2.2kW ~ 4.0kW   |      |      |     |    |   |     |   |   |   |
|------------------------|---|----|----|----|---|--------------------------|------|------|-----|----|---|-----|---|---|---|
| R                      | S | T  | B1 | B2 |   | R                        | S    | T    | B1  | B2 | U | V   | W |   |   |
|                        |   |    | U  | V  | W |                          |      |      |     |    |   |     |   |   |   |
| Capacity 5.5kW ~ 7.5kW |   |    |    |    |   | Capacity 11.0kW ~ 22.0kW |      |      |     |    |   |     |   |   |   |
| B1                     |   | B2 | U  | V  | W | R                        | S    | T    | P1  | B1 |   | N   | U | V | W |
| R                      | S | T  |    |    |   | (L1)                     | (L2) | (L3) | (+) |    |   | (-) |   |   |   |

# Standard Diagram

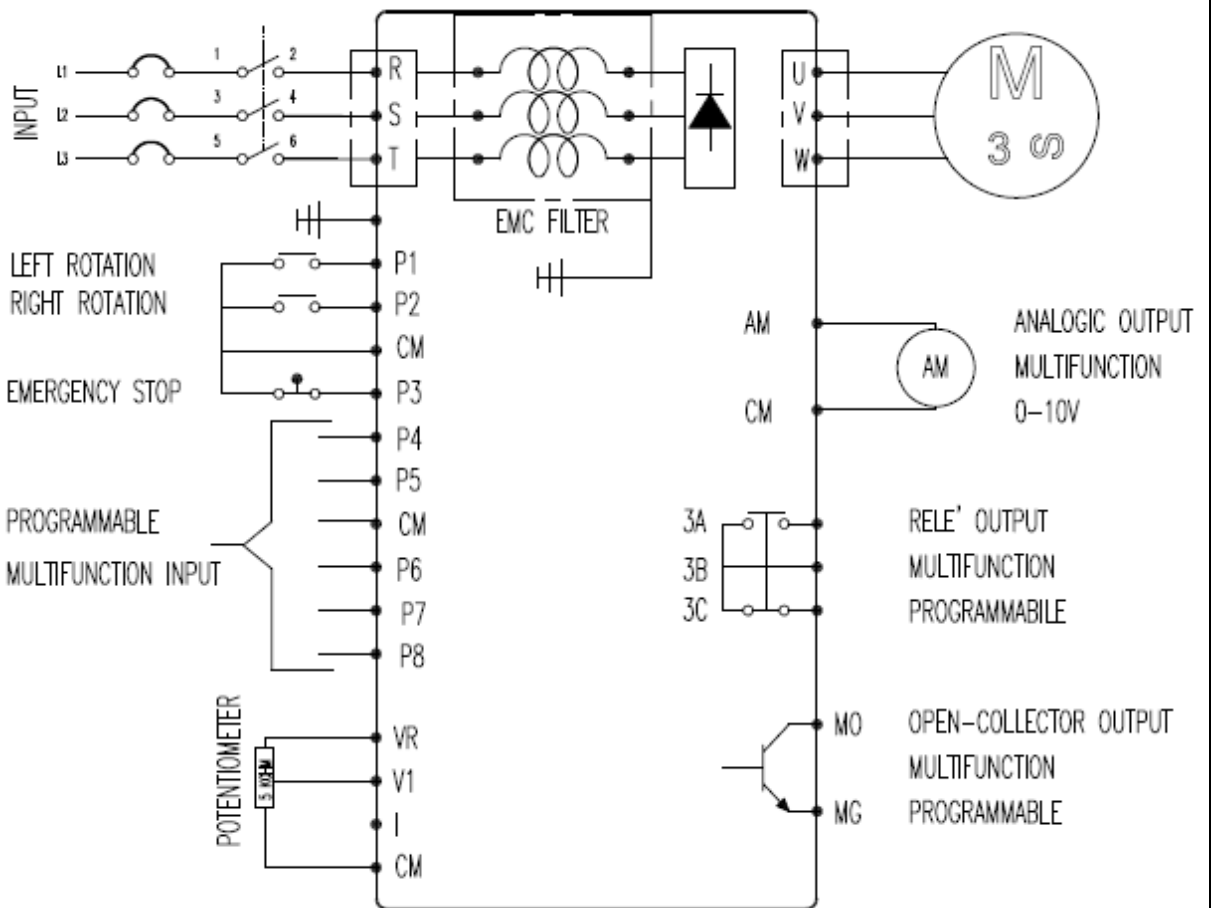

**Standard Diagram connection with command on board:**

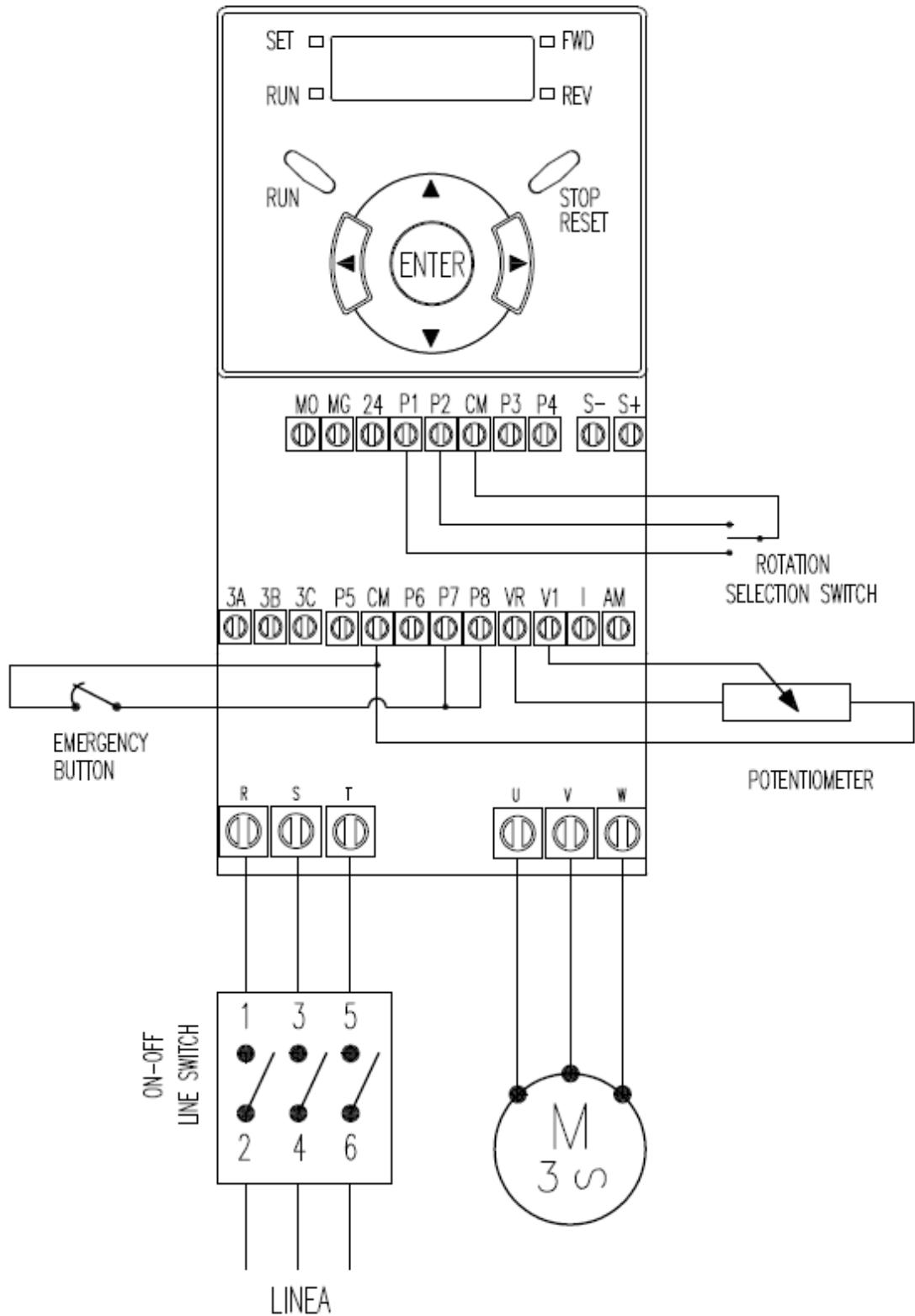

# CONNECTION DIAGRAM FOR DRIVEMOT WITH FORCED VENTILATION AND BRAKE

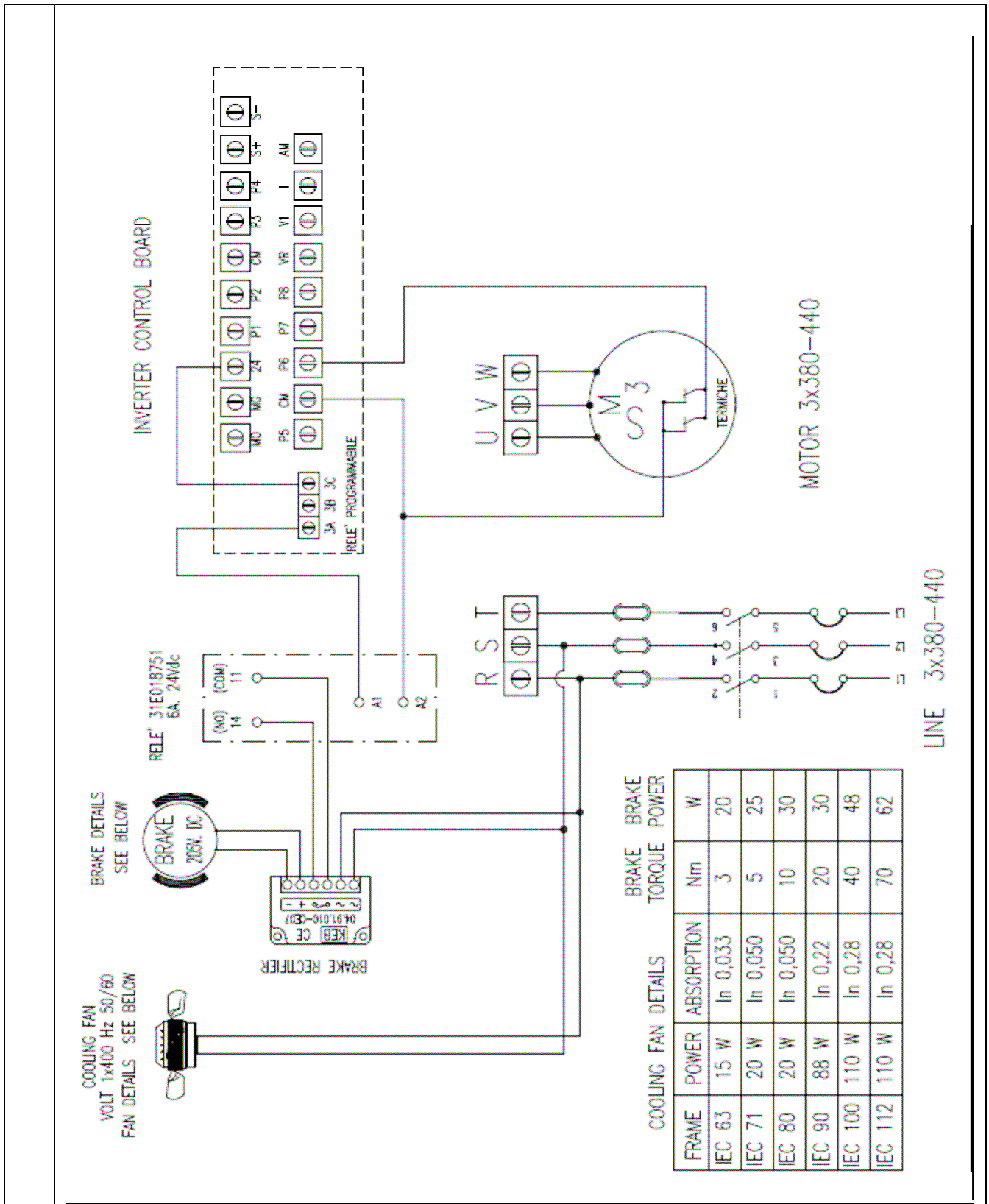

# CONNECTION DIAGRAM FOR DRIVEMOT WITH SINGLE PHASE POWER

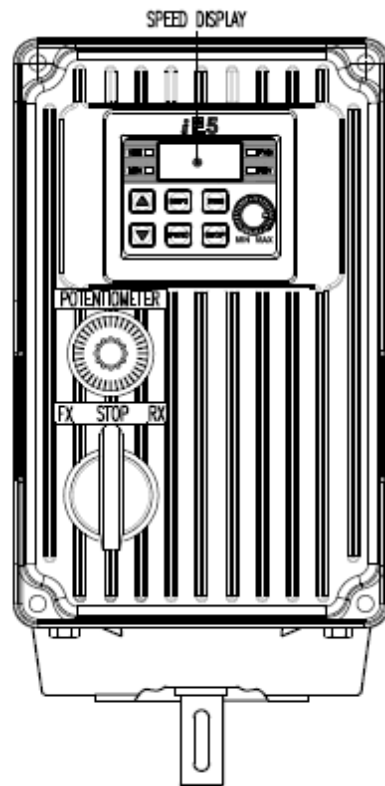
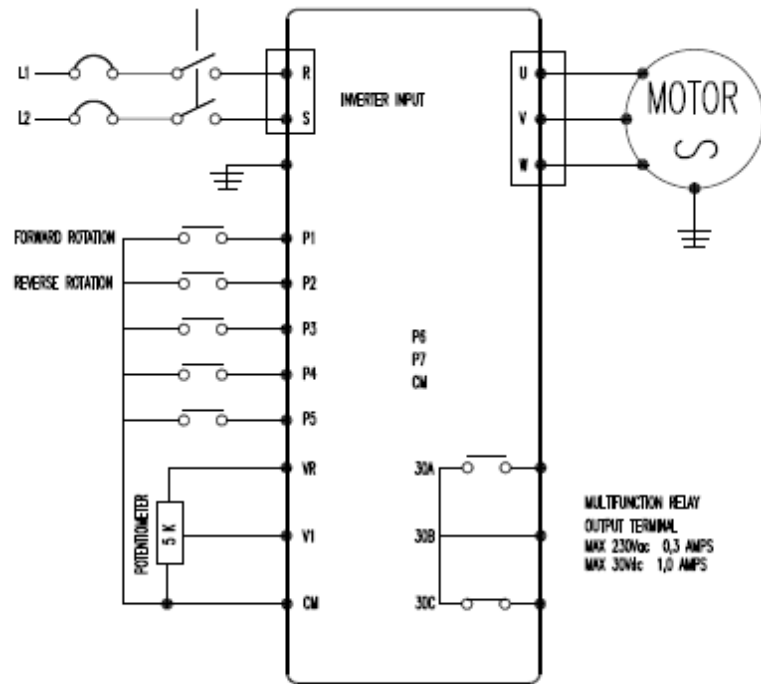



# CONNECTION DIAGRAM FOR DRIVEMOT WITH DRIVE OPTIONS

