

ALMATEC®

MM SERIES



Where Innovation Flows

STAINLESS STEEL AIR-OPERATED DOUBLE-DIAPHRAGM PUMPS
FOR THE FOOD & BEVERAGE INDUSTRY

PSG
a **DOVER** company

almatec.de



MM Series at a Glance

- Air-operated pumps meeting the special requirements of the food and beverage industry by using of food-grade wetted materials and a construction based on the cleaning demands
- Modular design for easily exchange of the connections and future technical variations
- Available in three sizes: ½", 1", 1 ½"
- Different hygienic manifold options including an open buttwelding end (small and easy to adapt), orientation of inlet and outlet can be adjusted just by turning the manifolds
- Stainless-steel machined housings SS316L, surface finishing grade 3.2 µm (0.8 µm as option)
- Easy and good cleanability (CIP/SIP capability) due to smooth and steady product channels
- Low shear fluid transport including solid handling
- Material conformity to FDA, EC1935 and ATEX
- Good suction head, self-priming and dry run capability
- Easy disassembly of the fluid path
- Stroke counting and diaphragm monitoring available as accessories
- Smooth diaphragms without disc
- Diaphragms, ball valves and O-rings made of PTFE or EPDM
- Maintenance-free air control system PERSWING P® without dead spot, oil-free
- No drives, no rotating parts, no shaft seals within the fluid
- For cleaning processes short-term temperature range up to 130 °C (266 °F)
- Easy to start up, step-less control via the air volume and pressure
- Wear parts compatible to other Almatec pump series



Cleaning and Hygienic Standards

All materials and the design of the pump are well suited for CIP and SIP cleaning. The hygienic standards EC1935/2004 (for pumps in H-version) and FDA are observed. In addition, the pumps are ATEX conform according to 2014/34/EU directive.



Pump Models:

MM 15: Maximum flow rate of 3.5 m³/h (15.4 gpm)

MM 25: Maximum flow rate of 9.2 m³/h (40 gpm)

MM 40: Maximum flow rate of 20 m³/h (88 gpm)

Functional Principal

The ALMATEC MM Series is based on the functional principle of air-operated double-diaphragm pumps. The basic configuration consists of two external product housings with a center block between them. Each of the product housings contains a product chamber which is separated from the center block by a diaphragm. The two diaphragms are interconnected by a piston rod. Directed by an air control system, they are alternately subjected to compressed air so that they move back and forth.

In the first figure, the compressed air has forced the left-hand diaphragm towards the product chamber and displaced the liquid from that chamber through the open valve at the top to the discharge port. Liquid is simultaneously drawn in by the right-hand diaphragm, thus refilling the second product chamber. When the end of the stroke is reached, it reverses automatically and the cycle is repeated in the opposite direction. In the second figure, liquid is drawn in by the left-hand diaphragm and displaced by the right-hand diaphragm. The liquid is displaced – and thus conveyed – by the compressed air. The diaphragms merely serve as barriers and are not pressurized. This is a fact of decisive importance for the service life of the diaphragms.

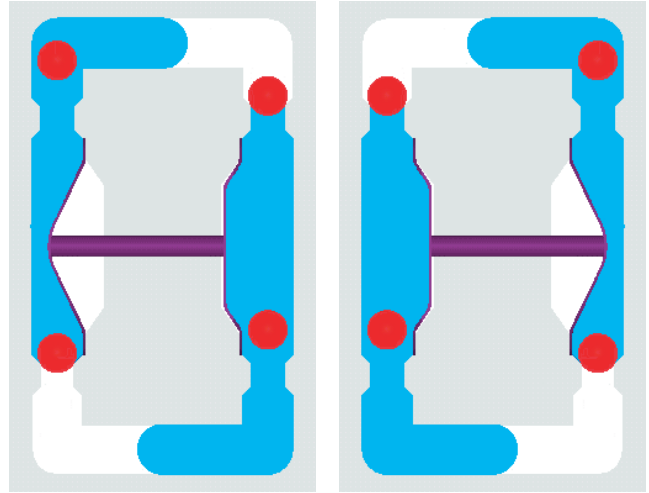

Application Examples

- Transfer and filling of beverages, sauces, toppings etc.
- Dosing of food and beverage ingredients
- Processing of meat, pastry and dough, smoothies, fruit pulp, candies
- Transfer and filling of cosmetics





More Special Features

The pump design is reflected in the name “MM”, as it refers to “modular metal”. The modularity allows to easily exchanging the connection pieces to the standard the customer requires – a frequent topic in hygienic applications. The orientation of inlet and outlet to each can be adjusted by turning the manifold. The lower manifold, however, is always the pump inlet, the upper one the outlet.



The housing is made from stainless steel 1.4404 (SS316L). The wetted surfaces come with a surface roughness of maximum 3.2 μm . An optional version with 0.8 μm is available, too. Soft redirections without rotating parts and shaft seals in the product chamber together with the principle-related gentle displacement result in low shear and a special suitability for the supposed applications.

The three pump sizes MM 15, MM 25 and MM 40 achieve max. capacities of 3.5 / 9.2 / 20 m^3/h (15.4 / 40 / 88 gpm) resp. a maximum. discharge pressure up to 7 bar (100 psig) and a short-term temperature range up to 130 $^{\circ}\text{C}$ (266 $^{\circ}\text{F}$) for cleaning processes.

Diaphragms, Ball Valves, Air Control System

The surface of the ALMATEC diaphragms is smooth and not interrupted by any seals. Due to the integrated metal core, they do not require diaphragm discs which frequently give rise to leaks. ALMATEC diaphragms have always been designed from the “PTFE” point of view. Result: ALMATEC diaphragms have a large diameter and short stroke with low flexural load. ALMATEC diaphragms for the MM series are available in the materials EPDM (FDA) or PTFE/EPDM-compound. Ball valves are robust and insensitive against solids since they only form a linear seal with the valve seat. They are available in EPDM and PTFE.

The MM pumps are equipped with the patented PERSWING P® air control system. This metal-free, pneumatically pilot-operated control system ensures accurate reversal of the main piston and is characterized by low noise levels. Only two moving parts ensure that there is absolutely no dead center in the PERSWING P® control system. It does not require maintenance, operates without any lubrication whatsoever and is made up of no more than four different parts. The complete cartridge can be replaced easily. PERSWING P® is a precision control system and therefore requires clean, oil-free compressed air to ensure its optimal function.

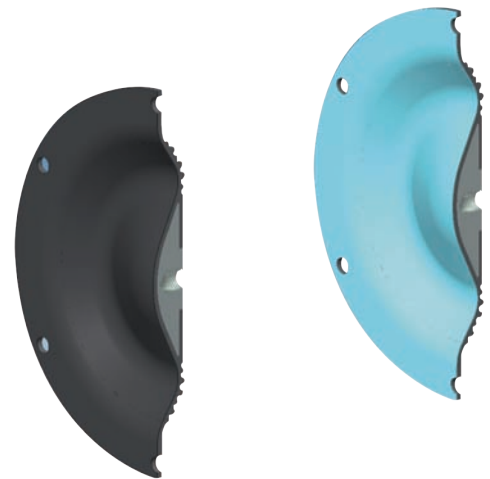

Optional Equipment

Connection Options

Inlet and outlet orientation can easily be adjusted in between “U-Shape” (inlet and outlet on the same side) and “Z-Shape” (inlet and outlet at opposite sides). The connection options are:

- Code A1 - Screwed aseptic pipe connection (DIN 11864-1)
- Code A2 - Aseptic flange (DIN 11864-2)
- Code A3 - Aseptic clamp pipe connection (DIN 11864-3)
- Code M – Milk pipe connection (DIN 11851)
- Code T - TriClamp connection (DIN 32676)
- Code S - Open buttwelding end (small and easy to adapt)



Diaphragm Monitoring (code D)

A capacitive sensor installed in the pump muffler detects all liquids and in case of a diaphragm rupture it outputs a corresponding signal to a controller which then triggers an alarm or disconnects the pump via a connected solenoid valve.



Stroke Counting (code C)

A sensor is installed in the center block of the pump to count the strokes. The diaphragm movement is scanned without contact. The issued sensor pulses can be output to existing detectors or to a stroke counter (can also be supplied). When the preset value is reached, the stroke counter outputs a signal which can then be processed further, for instance in order to shut down the pump via a solenoid valve. Another possibility is the pneumatical stroke counting.

Active Pulsation Dampers

Due to their design, pumps with oscillating action produce a pulsating flow. Although the double-acting design of the ALMATEC pumps and the direct pneumatic drive have already greatly reduced the pulsation, a pulsation damper must still be installed on the discharge side in order to obtain a virtually uniform flow. The ALMATEC dampers of the P series are self-regulating. As in the ALMATEC pumps, the diaphragm merely serves as a barrier between product and air chamber and is therefore always without pressure. If the pressure on the product side drops due to changes in the operating conditions, the pressure on the other side of the diaphragm will decline accordingly. As soon as the pressure on the product side rises, the pressure on the other side will increase as well. This automatic adjustment optimizes the diaphragm setting and ensures a consistently good damping effect.

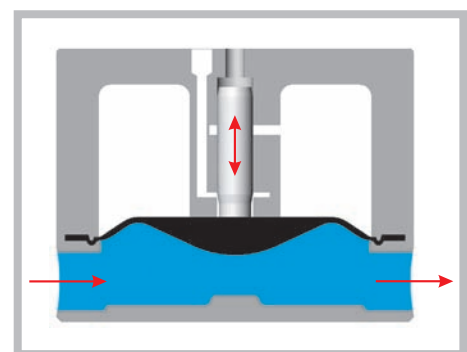

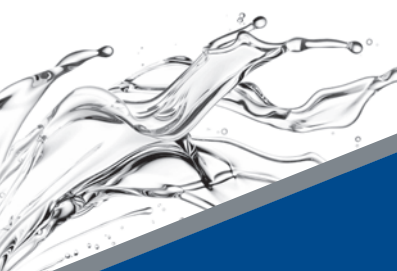

Technical Data

Pump Size		MM15	MM25	MM40
Dimensions – mm (inch):	Length	150 (5.9)	200 (7.9)	270 (10.6)
	Width	303 (11.9)	362 (14.3)	439 (17.3)
	Height	413 (16.3)	553 (21.8)	740 (29.1)
Nominal port size		1/2"	1"	1 1/2"
Air connection (BSP)		1/4"	1/4"	1/4"
Weight – kg (lbs)		14 (31)	33 (73)	82 (181)
Max. particle size of solids – mm (inch)		4 (0.16)	7 (0.28)	11 (0.43)
Suction head, dry – mWS (ftWC)		3 (9.8)	3 (9.8)	4 (13.1)
Suction head, wet – mWS (ftWC)		9 (29.5)	9 (29.5)	9 (29.5)
Max. permissible driving pressure – bar (psig)		7 (100)	7 (100)	7 (100)
Max. permissible operating temperature - °C (°F)		80 (176)	80 (176)	80 (176)

Viscosity and Pump Capacity

The capacity specified in the pump performance charts generally refer to water (1 mPa·s).

The value must be reduced correspondingly when pumping media with higher viscosity. The design capacity can be read off directly from the graph and the corresponding pump size selected.

The example shown here is based on a required capacity of 10 m³/h with a product viscosity of 6000 mPa·s. The dash-dotted line intersects the design capacity scale at 17 m³/h.

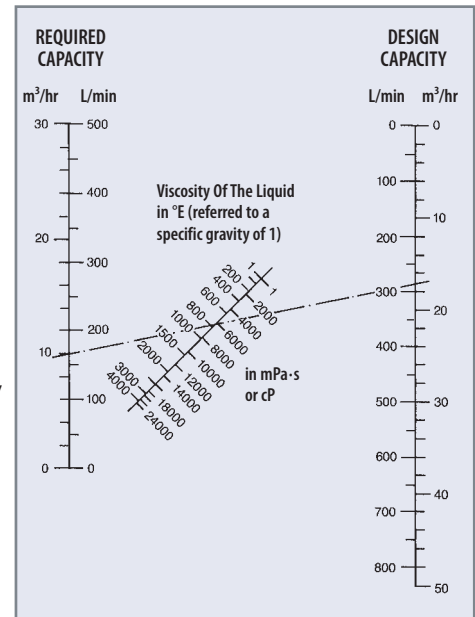

Code System

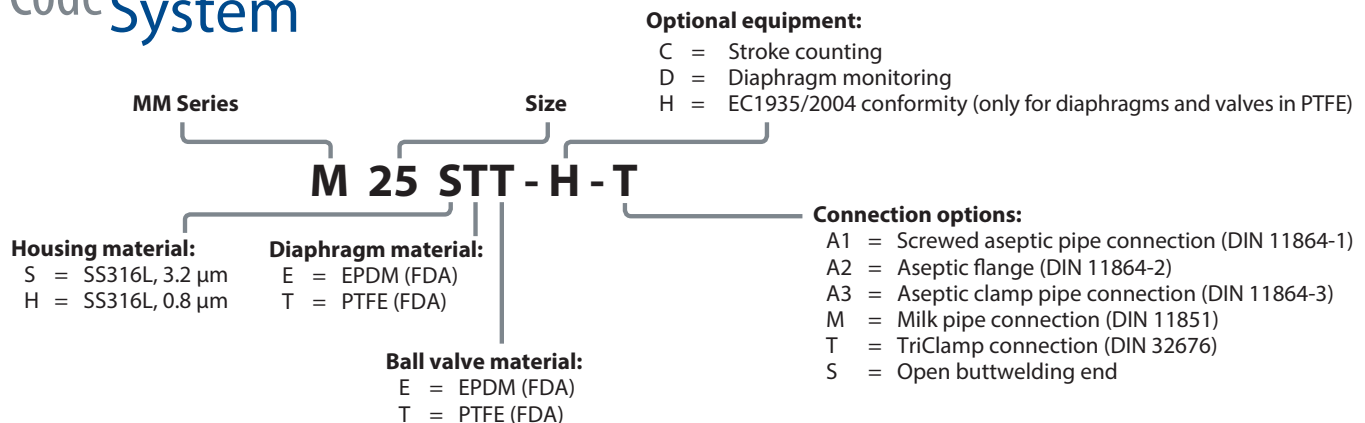

Performance Charts

The following data refer to water at 20°C / 68°F (referring to DIN EN ISO 9906)

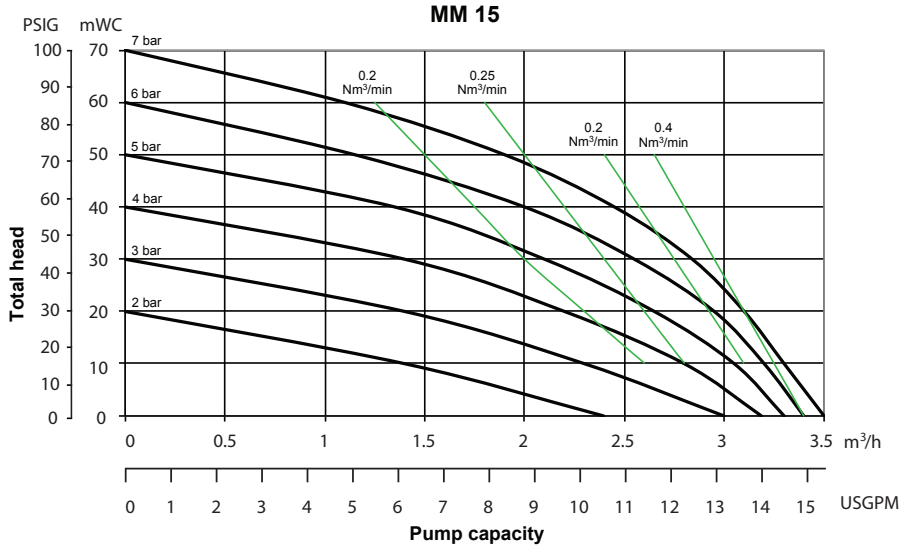

MM 15



MM 25

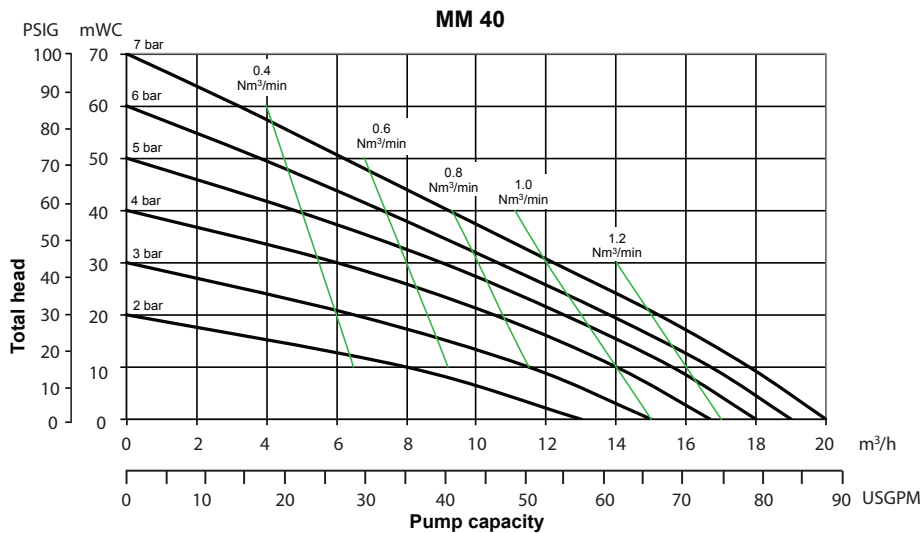



Where Innovation Flows

ALMATEC®

Almatec Maschinenbau GmbH
Carl-Friedrich-Gauß-Straße 5
47475 Kamp-Lintfort, Germany
T: +49 (0) 2842/961-0
F: +49 (0) 2842/961-40
info@almatec.de
almatec.de

PSG® reserves the right to modify the information and illustrations contained in this document without prior notice. This is a non-contractual document. 04-2018

Authorized PSG Partner: