

TECHNICAL CHARACTERISTICS

		STANDARD	AVAILABLE OPTIONS
Technology		Peristaltic	
Maximum Flow rate at 1 cSt L/h (GPM)		18000 (79.25) (1)	
Ports		ISO PN16 flanges	ISO PN20 / ANSI150 flanges
Dimensions mm (in.)	A	950 (37.40)	
	B	825 (32.48)	
	C	554 (21.81)	
	D	164 (6.46)	
	E	835 (32.87)	
Weight kg (lbs)		295 - 345 (650 - 760)	

(1) Intermittent duty only.

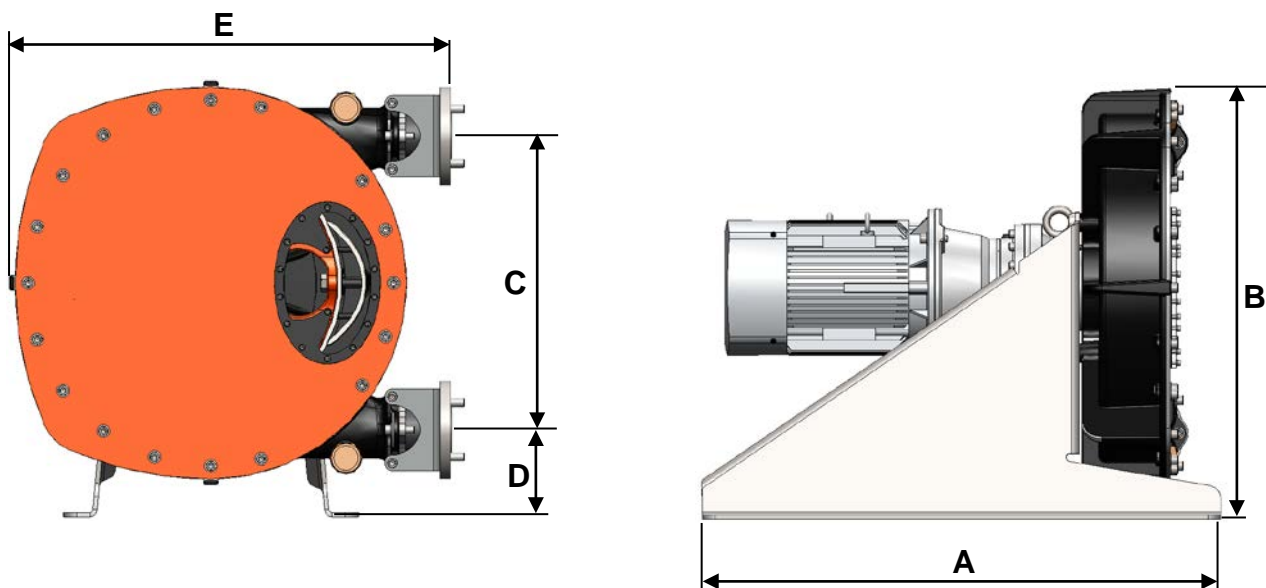

OPERATING LIMITS

	STANDARD MATERIALS	OPTIONAL MATERIALS
Minimum temperature °C (°F)	0 (32)	
Maximum temperature °C (°F)	70 (158)	80 (176) with EPDM hose
Maximum viscosity cSt (SSU)	40000 (185000)	
Maximum differential pressure bar (psi)	15 (217)	
Maximum speed rpm	90 (1)	
Maximum solid particle size mm (in)	9 (0.35)	
Maximum soft particle size mm (in)	16 (0.63)	

(1) Intermittent duty only.

MATERIALS OF CONSTRUCTION

Part No	PART NAME	STANDARD MATERIALS	AVAILABLE OPTIONS
1	Body	Ductile Iron	
2	Cover	Carbon steel	
3	Rotor	Ductile Iron	
5	Shoe	Ductile Iron	
10	Cover seal	NBR	
26	Shaft seal	NBR	
12	Insert	316L Stainless steel	PPH, PVDF
16	Hose	NR	NBR, NBR-FDA, EPDM, Hypalon
18	Bracket	Zinc plated steel	
21	Frame	Zinc plated steel	
	Bolts, screws, washers	Zinc plated steel	
25	Window	Polycarbonate	

